

14 | GLEITPROFILE

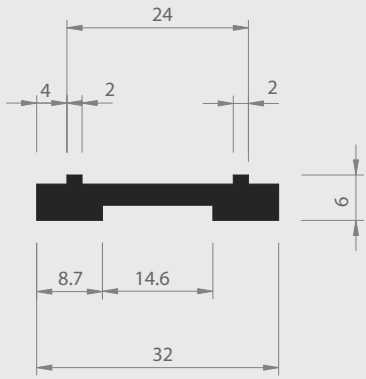

Nr.22/32H

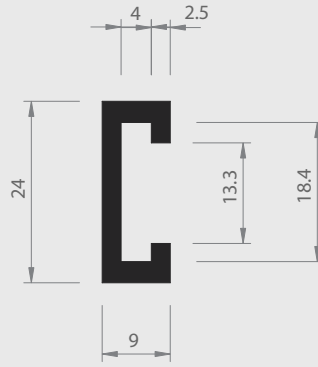

Nr.22/33 H

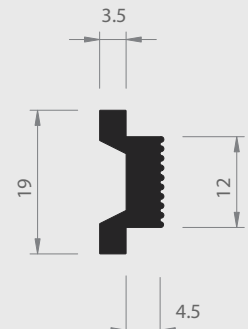

Nr.23/33 H

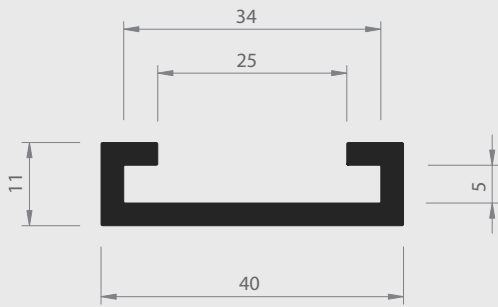

Nr.22/31 H

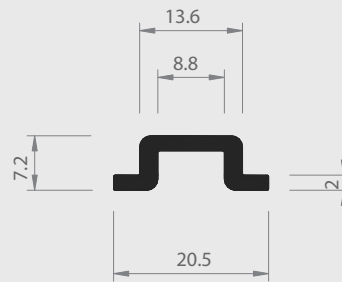

Nr.23/32 H

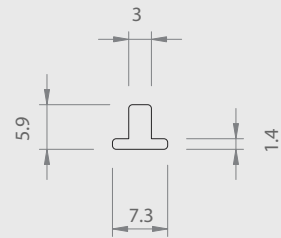

Nr.23/38 HDPE

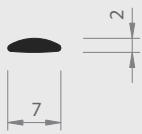

Nr. 06/38 H



Nr. 11/50 H

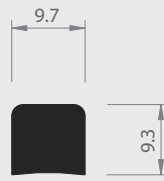

Nr. 21/30a H

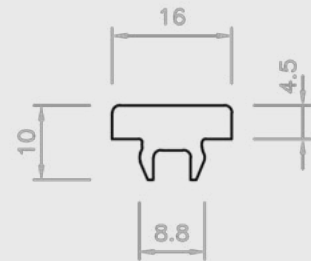

Nr. 25/15 HDPE

■ = Hart PVC

■ = Weich PVC | HH = Halbhart PVC

□ = Andere Kunststoffe

14 | GLEITPROFILE

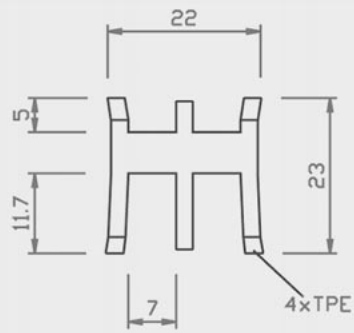

Nr. 18/94 PP+TPE

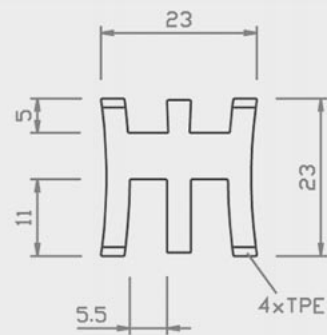

Nr. 18/93 PP+TPE

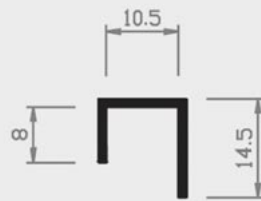

Nr. 21/37 H

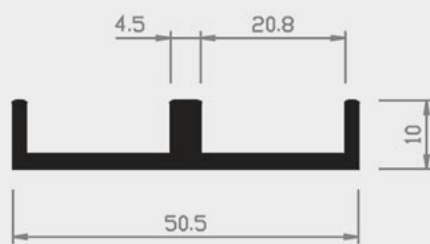

Nr. 20/26 H

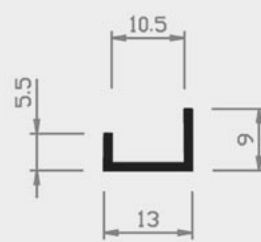

Nr. 21/38 H

= Hart PVC
 = Weich PVC | HH = Halbhart PVC
 = Andere Kunststoffe

14 | GLEITPROFILE

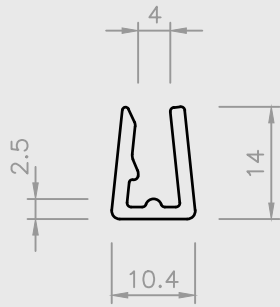

Nr. 21/20 HDPE

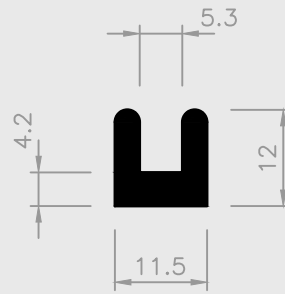

Nr. 64/36 H

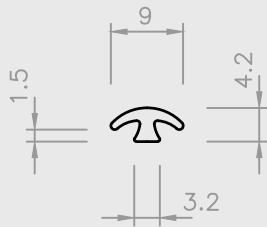

Nr. 23/40 PP

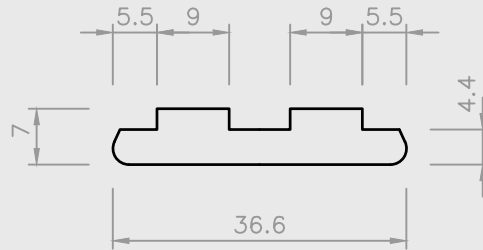

Nr. 46/01 POLYKETON

■ = Hart PVC ■ = Weich PVC | HH = Halbhart PVC □ = Andere Kunststoffe