

Rohr- und Rundprofile

Profil Nr.	Außen - ø mm	Wandstärke mm	Innen - ø mm
57/10 PP	3,2		1
50/30 W	5	0,5	
50/30a W	6	0,6	
52/32 W	6	1	
52,32a H	6,5		5,5
50/32 H	7,3	0,5	6,3
53/32 H	8		6
53/32a H	8		4
50/34a H	9,5	0,8	
50/34 W	10	0,8	
54/32 W	11	1,5	
54/31 H	12	0,55	
54/32 H	12	1,3	
54/32c H	12		10
54/32a H	~13	1,4	
54/14 H	14		10
54/24 PP	14,6		12,5
54/01 W	16		13
54/19 H	17	0,7	
54/18 W	17	1	
54/17 H	17	2	
54/02 W	19		15
54/37 PE/PP	21,4	3	
54/06 W	22		18
21/32a H	22,8	1,5	
21/32 H	22,9		15,9
54/20 H	23	0,7	
56/32 H	24	1	
55/32 W	24	2	
57/32 H	25	1,5	
54/03 W	26		22
20/32 H	28		23
54/04 W	29		24
54/29	30		22
54/42 H	38		35
55/39 PS	39,5		34,8
54/44 PMMA	43		39,9
54/43 H	43		38
54/48 H	44		39

■ = Hart PVC

■ = Weich PVC | HH = Halbhart PVC

□ = Andere Kunststoffe

17 | ROHR- UND RUNDPROFILE

Rohr- und Rundprofile

Profil Nr.	Außen - ø mm	Wandstärke mm	Innen - ø mm
54/52 H	32	4,0	24
54/53 H	44	4,5	35
54/55 PP	15,8	1,7	12,4
21/32A H	22,8	1,7	19,4
54/17B H	17	1,6	13,8
54/56 PP	19	1,6	15,8

■ = Hart PVC ■ = Weich PVC | HH = Halbhart PVC □ = Andere Kunststoffe

17 | ROHR- UND RUNDPROFILE



Nr. 54/10 W



Nr. 56/10 W
2-farbig



Nr. 55/10 W



Nr. 50/13 W



Nr. 50/12 H



Nr. 53/33 W



Nr. 51/32 W

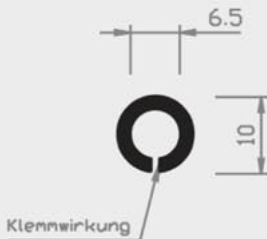

Nr. 50/22 H

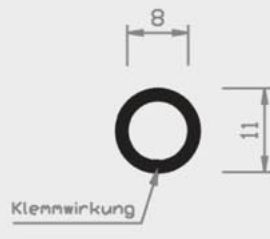

Nr. 50/32a H



Nr. 54/19a H

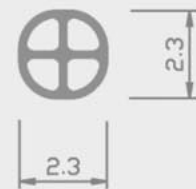

Nr. 1/32 w

M 5:1

■ = Hart PVC

■ = Weich PVC | HH = Halbhart PVC

□ = Andere Kunststoffe

17 | ROHR- UND RUNDPROFILE

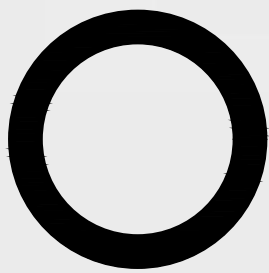

Nr 54/52 H

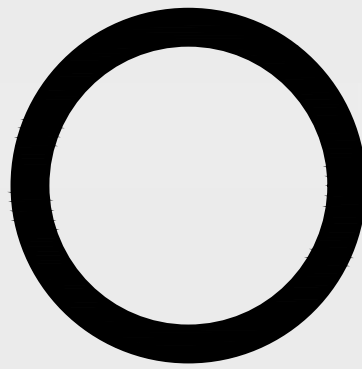

Nr 54/53 H

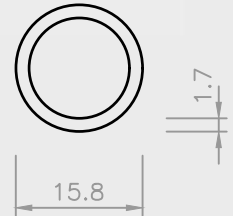

Nr 54/55 PP

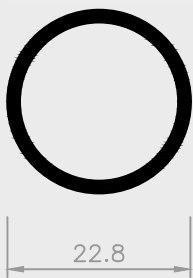

Nr 21/32A H

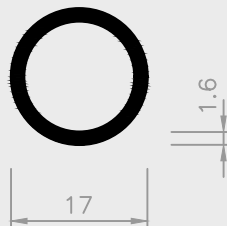

Nr 54/17B H

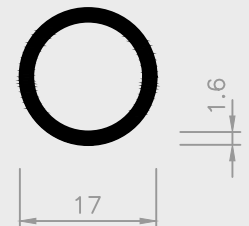

Nr 54/56 PP

■ = Hart PVC

■ = Weich PVC | HH = Halbhart PVC

□ = Andere Kunststoffe

17 | ROHR- UND RUNDPROFILE

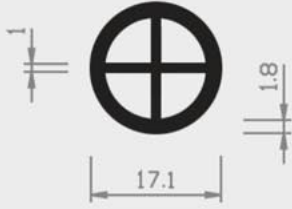

Nr. 54/16 H



Nr. 50/21 PE

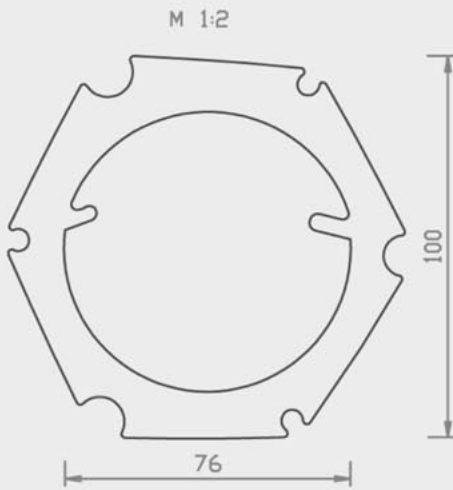

Nr. 22/46 PE
geschützt

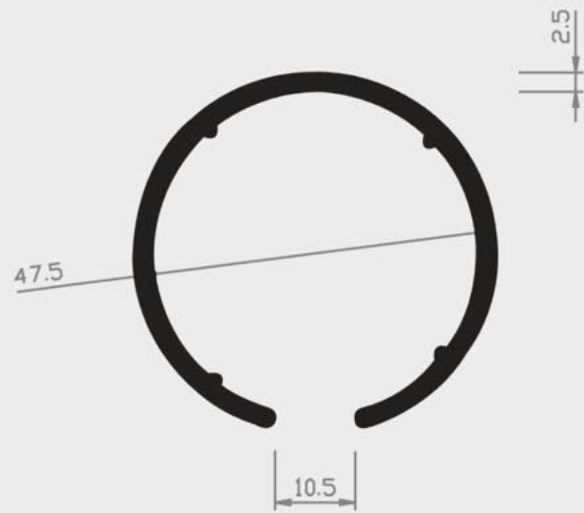

Nr. 54/21 H

■ = Hart PVC

■ = Weich PVC | HH = Halbhart PVC

□ = Andere Kunststoffe

Vollstab - rund

Profil Nr.	ø mm	Qualität / Material
50/08	1	H-PVC
50/09	1,8	H-PVC
50/10	3	H-PVC
53/11	4	H-PVC, PP
54/11	5	H-PVC, W-PP
56/11 A	6	W-PVC
56/11	6,5	H-PVC, W-PVC
57/11 A	7	W-PVC
57/11	8	W-PVC
55/13	8,6	PE
55/11 A	-8	H-PVC
55/11	-10	W-PVC
57/12	12	W-PVC

= Hart PVC
 = Weich PVC | HH = Halbhart PVC
 = Andere Kunststoffe