

04 | DICHTPROFILE

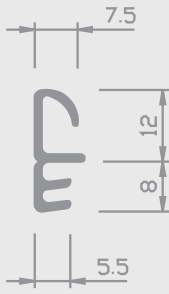

Nr. 14/12 W 12mm

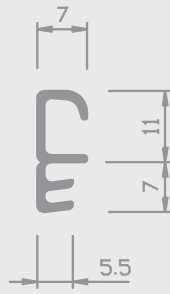

Nr. 14/12a W



Nr. 14/21 W



Nr. 14/22 W



Nr. 14/25 W

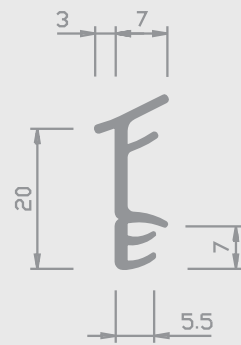

Nr. 15/4 W



Nr. 15/21 W



Nr. 15/20 W



Nr. 20/13 W

■ = Hart PVC

■ = Weich PVC | HH = Halbhart PVC

□ = Andere Kunststoffe

04 | DICHTPROFILE

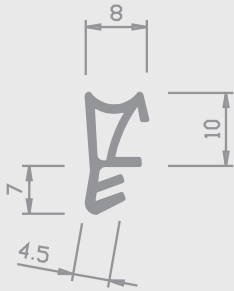

Nr. 12/1 W

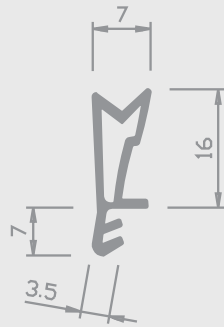

Nr. 12/4 W



Nr. 12/04a W

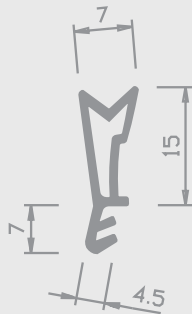

Nr. 12/13 W

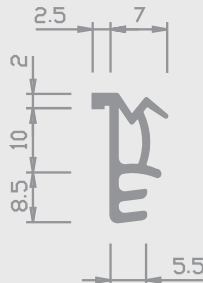

Nr. 13/1 W



Nr. 13/8 W



Nr. 13/18 W



Nr. 13/12 W 9mm



Nr. 14/12 W 10mm

■ = Hart PVC

■ = Weich PVC | HH = Halbhart PVC

□ = Andere Kunststoffe

04 | DICHTPROFILE

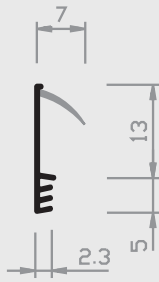

Nr. 20/17 H+W



Nr. 12/2 W

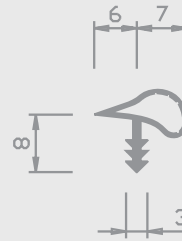

Nr. 14/5 W



Nr. 15/22 W



Nr. 15/23 W

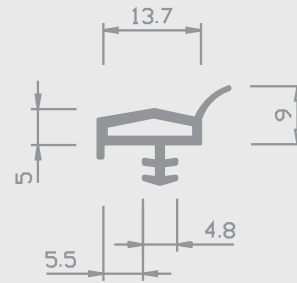

Nr. 12/5 W

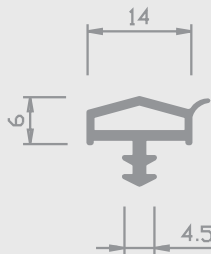

Nr. 12/9 W

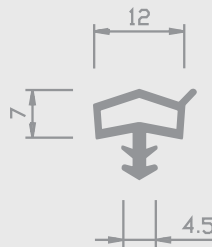

Nr. 12/10 W

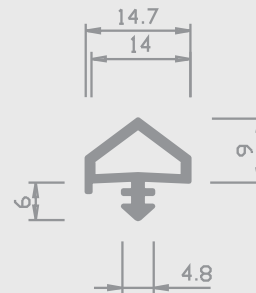

Nr. 13/2 W

= Hart PVC
 = Weich PVC | HH = Halbhart PVC
 = Andere Kunststoffe

04 | DICHTPROFILE

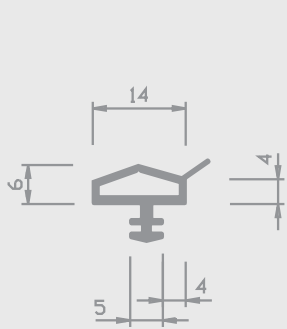

Nr. 13/10 W

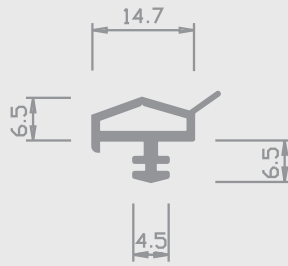

Nr. 13/10a W

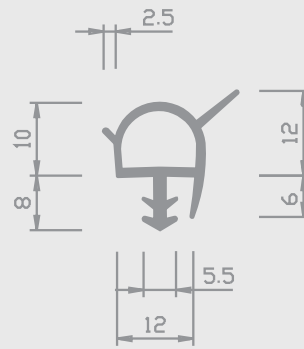

Nr. 13/12 W
geschützt

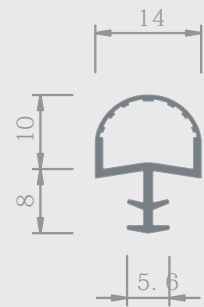

Nr. 14/23 W

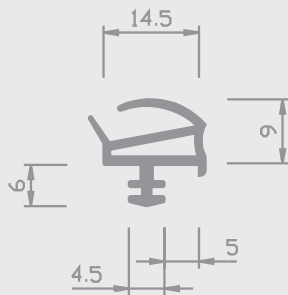

Nr. 13/19 W

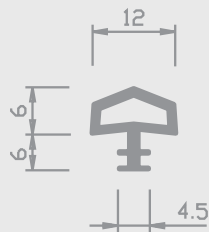

Nr. 14/4 W 12mm

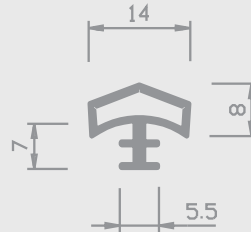

Nr. 14/4 W 14mm

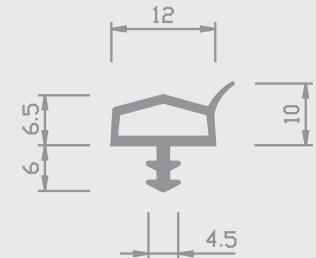

Nr. 13/27 W

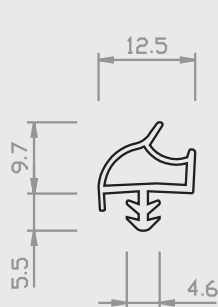

Nr. 13/29 TPE

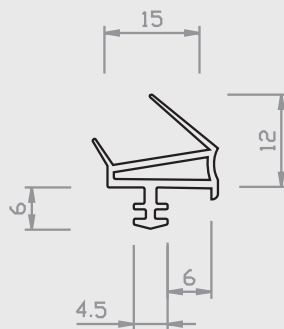

Nr. 13/20 TPE

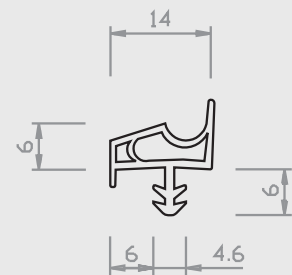

Nr. 13/23 TPE

■ = Hart PVC

■ = Weich PVC | HH = Halbhart PVC

□ = Andere Kunststoffe

04 | DICHTPROFILE

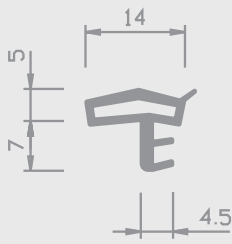

Nr. 15/8 W

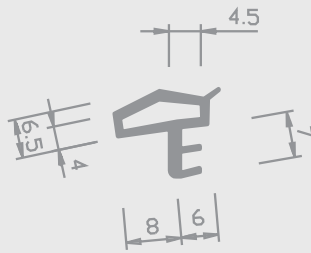

Nr. 15/8a W

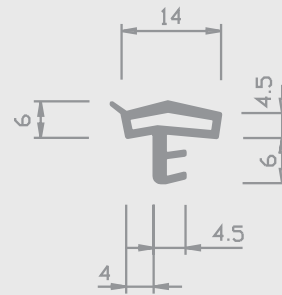

Nr. 15/10 W

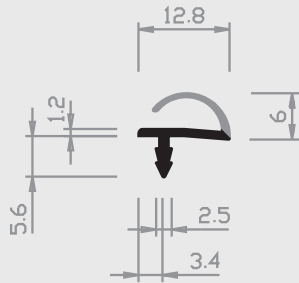

Nr. 22/14 H+W

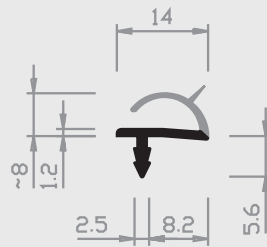

Nr. 22/14a H+W

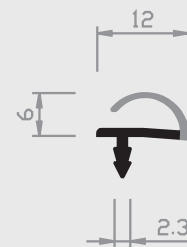

Nr. 22/14b H+W 12mm

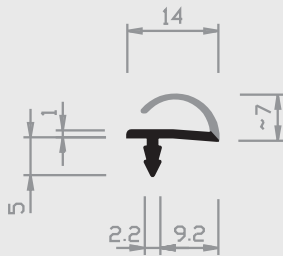

Nr. 22/13 H+W

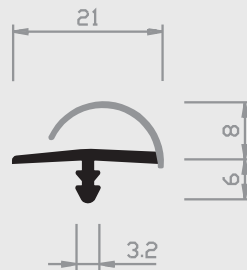

Nr. 32/14 H+W

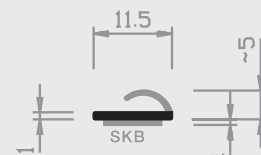

Nr. 22/10 H+W

■ = Hart PVC

■ = Weich PVC | HH = Halbhart PVC

□ = Andere Kunststoffe

04 | DICHTPROFILE

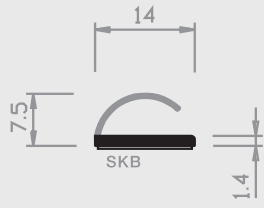

Nr. 22/16 H+W
selbstickleband

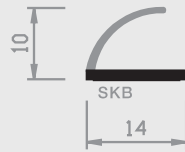

Nr. 22/16a H+W
selbstickleband

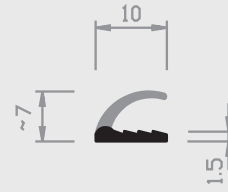

Nr. 22/20 H+W



Nr. 14/8 H+W

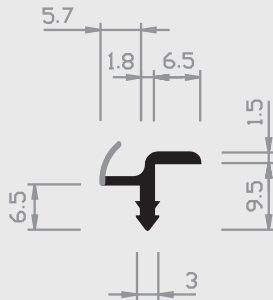

Nr. 21/14 H+W

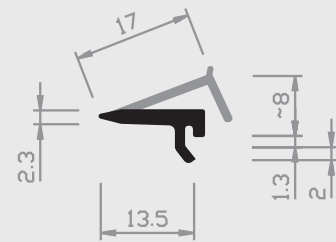

Nr. 26/16 H+W

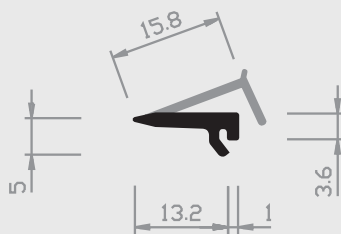

Nr. 26/16a H+W

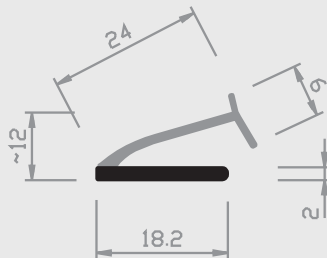

Nr. 26/17 H+W

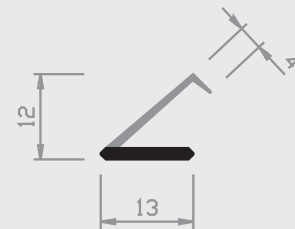

Nr. 26/19 H+W

■ = Hart PVC

■ = Weich PVC | HH = Halbhart PVC

□ = Andere Kunststoffe

04 | DICHTPROFILE

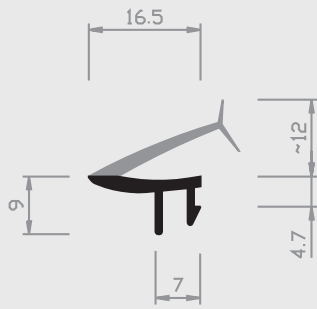

Nr. 26/20 H+W

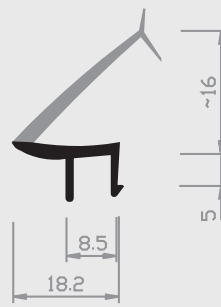

Nr. 26/21 H+W



Nr. 14/3 W

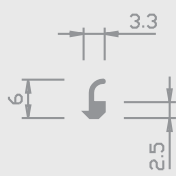

Nr. 11/71 W

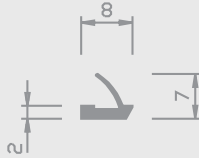

Nr. 14/1 W



Nr. 14/2 W



Nr. 14/26 W

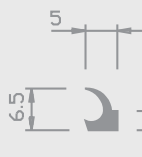

Nr. 14/47 W

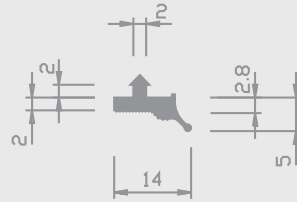

Nr. 15/15 W

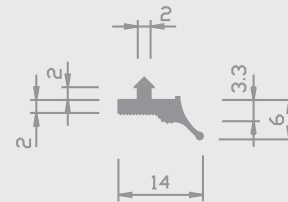

Nr. 17/15 W



Nr. 16/15 W

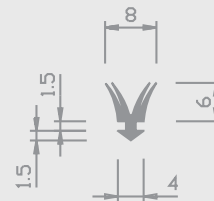

Nr. 19/15 W

= Hart PVC
 = Weich PVC | HH = Halbhart PVC
 = Andere Kunststoffe

04 | DICHTPROFILE

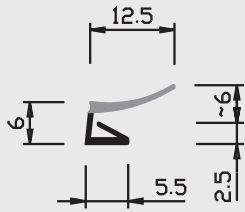

Nr. 5/2 H+W

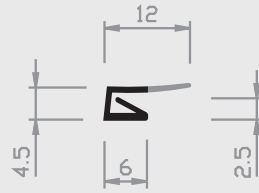

Nr. 5/3 H+W

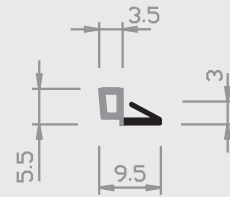

Nr. 5/4 H+W

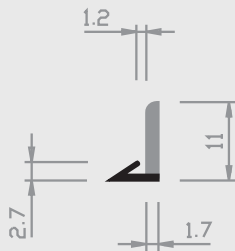

Nr. 6/1 H+W

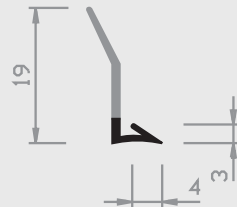

Nr. 6/2 H+W

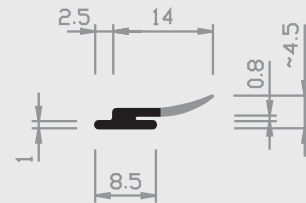

Nr. 5/5 H+W

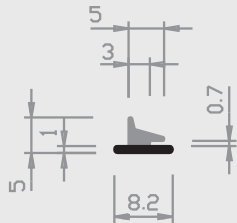

Nr. 5/6a H+W

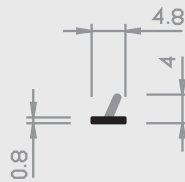

Nr. 15/13 H+W

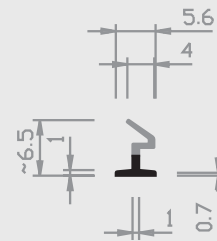

Nr. 15/17 H+W

■ = Hart PVC

■ = Weich PVC | HH = Halbhart PVC

□ = Andere Kunststoffe

04 | DICHTPROFILE

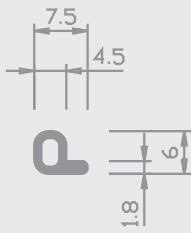

Nr. 32/15 W

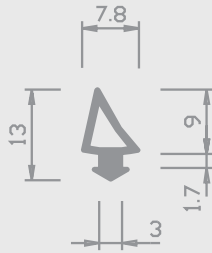

Nr. 13/9 W



Nr. 20/15 H+W

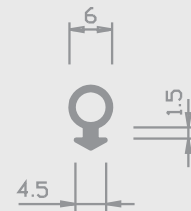

Nr. 21/13 W



Nr. 21/15 W

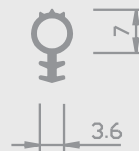

Nr. 21/12 W

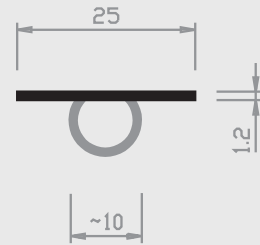

Nr. 5/16 H+W



Nr. 6/16 W

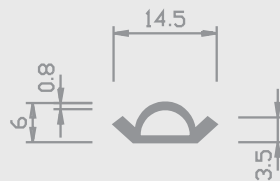

Nr. 6/16a W

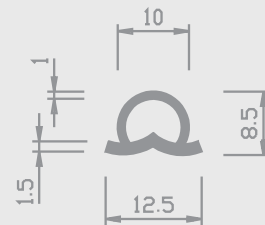

Nr. 6/16b W

= Hart PVC
 = Weich PVC | HH = Halbhart PVC
 = Andere Kunststoffe

04 | DICHTPROFILE

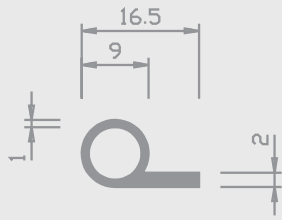

Nr. 32/17 W

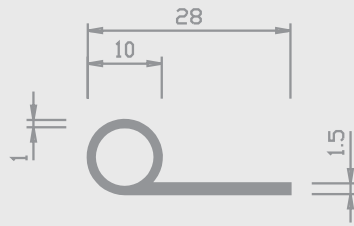

Nr. 32/18 W

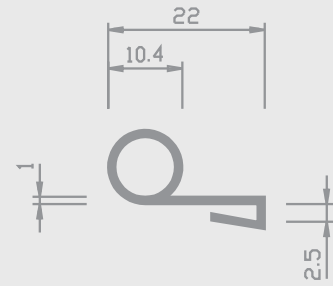

Nr. 32/19 W

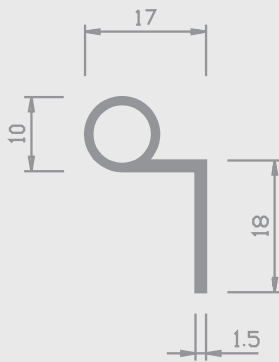

Nr. 32/20 W

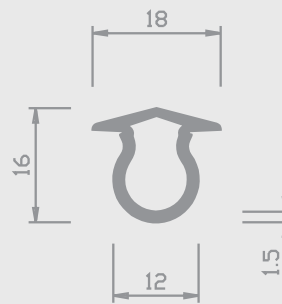

Nr. 6/15 W 12mm

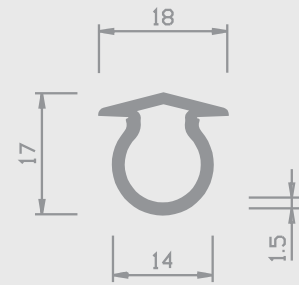

Nr. 6/15a W 14mm



Nr. 6/14 W 9mm



Nr. 6/14a W 12mm

= Hart PVC
 = Weich PVC | HH = Halbhart PVC
 = Andere Kunststoffe

04 | DICHTPROFILE

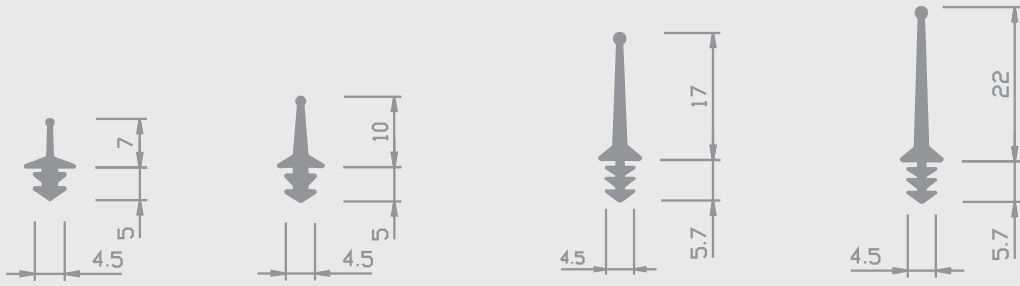

Nr. 13/5 W 7mm

Nr. 13/5 W 10mm

Nr. 13/5 W 17mm

Nr. 13/5 W 22mm

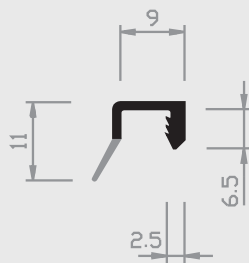

Nr. 14/9 H+W

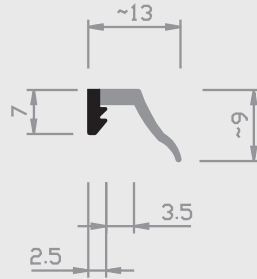

Nr. 14/20 H+W

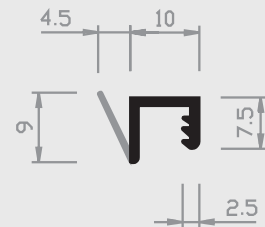

Nr. 14/10 H+W

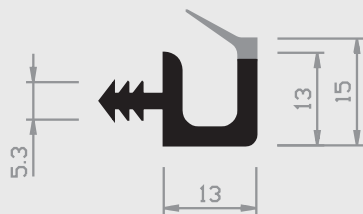

Nr. 21/19 H+W

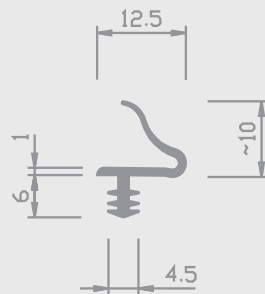

Nr. 22/12 W

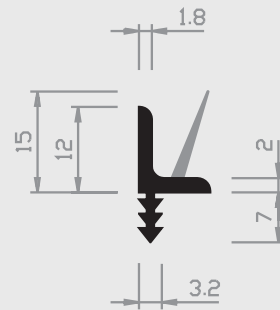

Nr. 22/18 H+W

= Hart PVC
 = Weich PVC | HH = Halbhart PVC
 = Andere Kunststoffe

04 | DICHTPROFILE

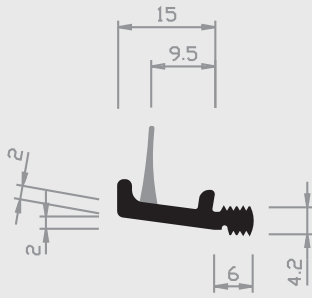

Nr. 23/18 H+W

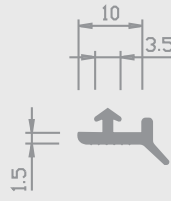

Nr. 27/15 W

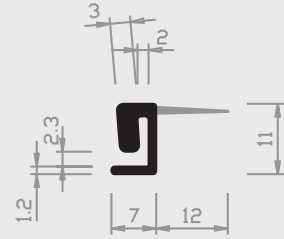

Nr. 28/16 H+W

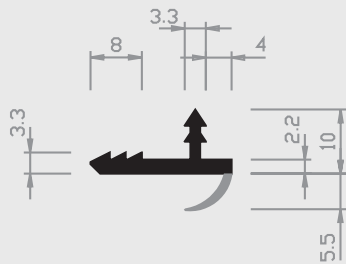

Nr. 30/15 H+W

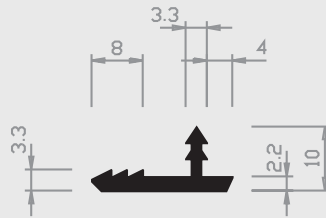

Nr. 30/16 H

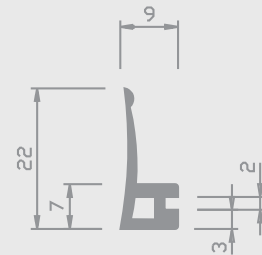

Nr. 12/3 W

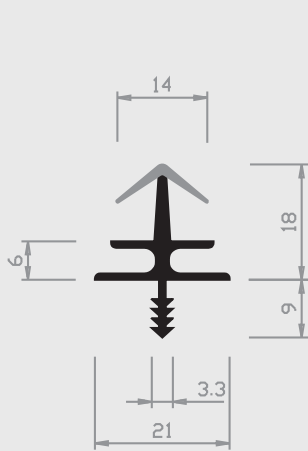

Nr. 33/14 H+W

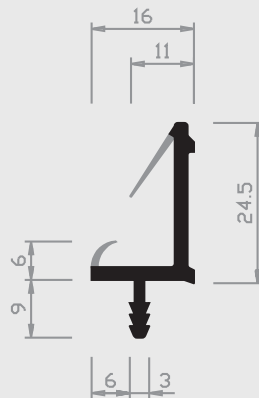

Nr. 8/14 H+W
geschützt



Nr. 15/12 W

■ = Hart PVC

■ = Weich PVC | HH = Halbhart PVC

□ = Andere Kunststoffe

04 | DICHTPROFILE

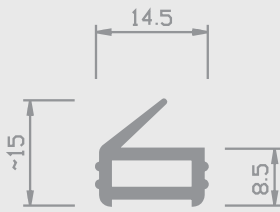

Nr. 8/16 W

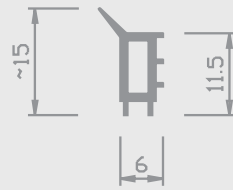

Nr. 8/19 W

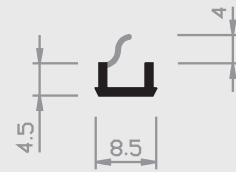

Nr. 16/8 H+W

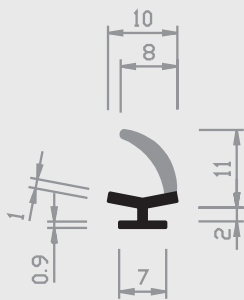

Nr. 15/19 H+W

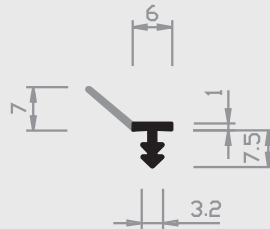

Nr. 18/17 H+W

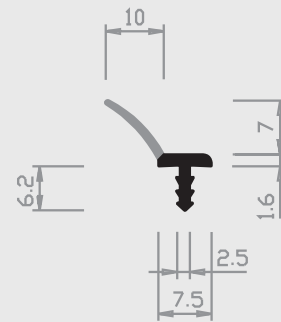

Nr. 18/15 H+W

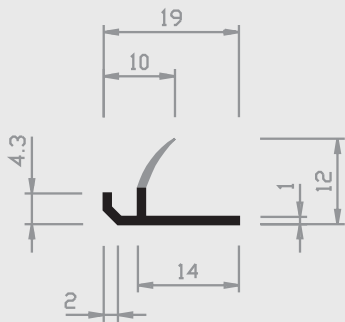

Nr. 26/15 H+W

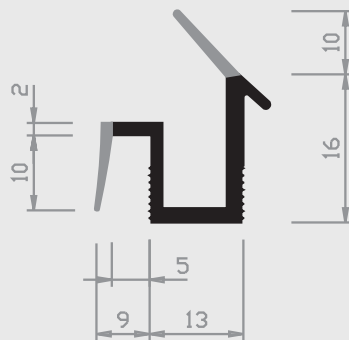

Nr. 28/14 H+W

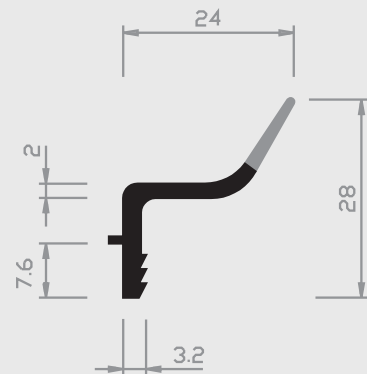

Nr. 29/37 H+W

■ = Hart PVC

■ = Weich PVC | HH = Halbhart PVC

□ = Andere Kunststoffe

04 | DICHTPROFILE

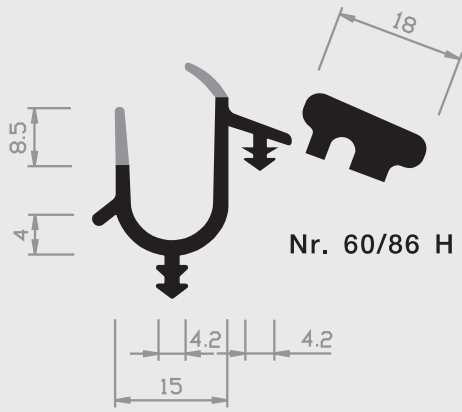

Nr. 60/86 H

Nr. 29/14 H+W

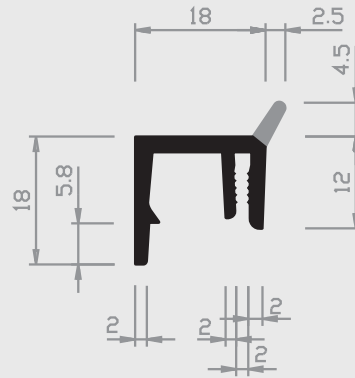

Nr. 29/15 H+W

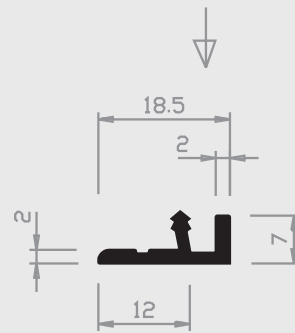

Nr. 29/16 H

= Hart PVC
 = Weich PVC | HH = Halbhart PVC
 = Andere Kunststoffe

04 | DICHTPROFILE



Nr. 28/15 W



Nr. 28/15a H+W

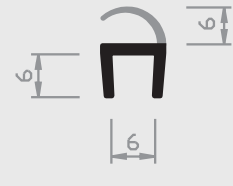

Nr. 28/15b H+W

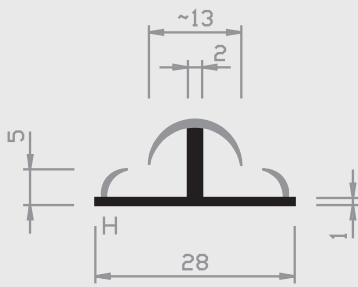

Nr. 5/15 H+W

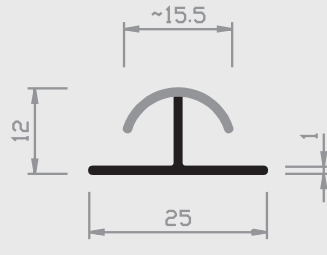

Nr. 5/16a H+W

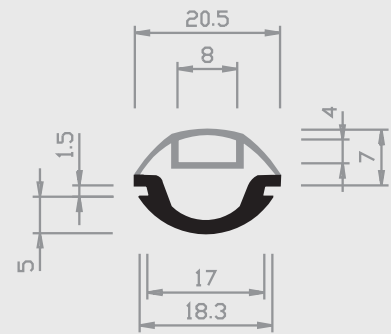

Nr. 7/17 H+W



Nr. 31/14 H+W

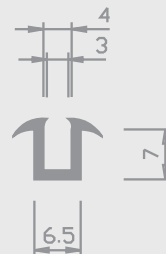

Nr. 16/14 W

= Hart PVC
 = Weich PVC | HH = Halbhart PVC
 = Andere Kunststoffe

04 | DICHTPROFILE

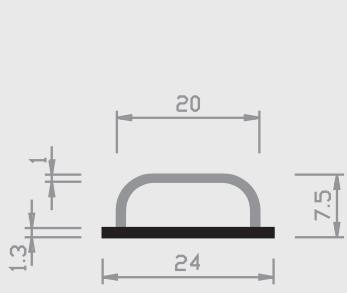

Nr. 7/15 H+W

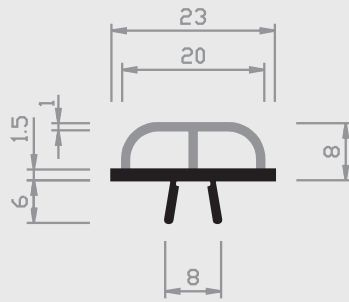

Nr. 9/15 H+W

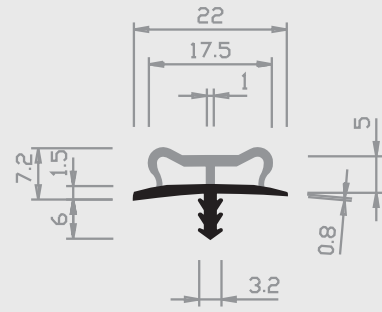

Nr. 9/16 H+W

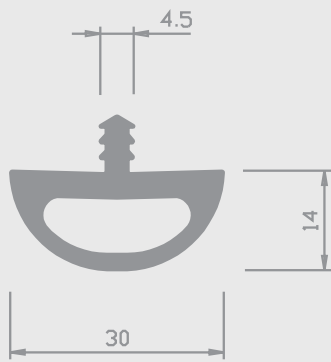

Nr. 23/14 W

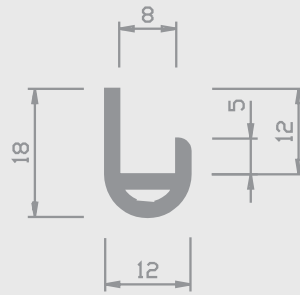

Nr. 15/14 W

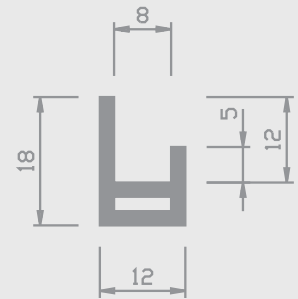

Nr. 14/14 W

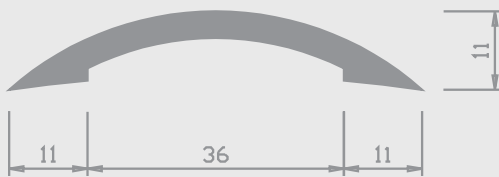

Nr. 44/33 HH

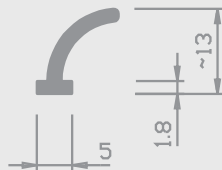

Nr. 12/20 W

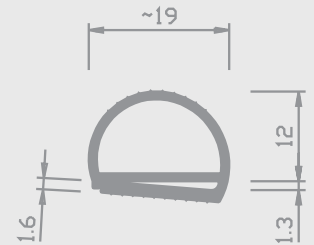

Nr. 30/17 W

= Hart PVC
 = Weich PVC | HH = Halbhart PVC
 = Andere Kunststoffe

04 | DICHTPROFILE

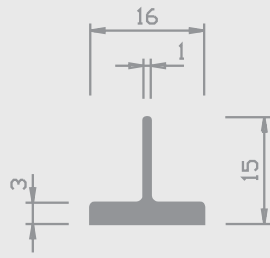

Nr. 13/4 W

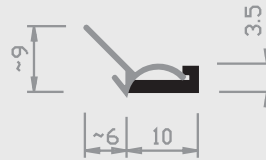

Nr. 14/27 H+W



Nr. 14/29 H+W

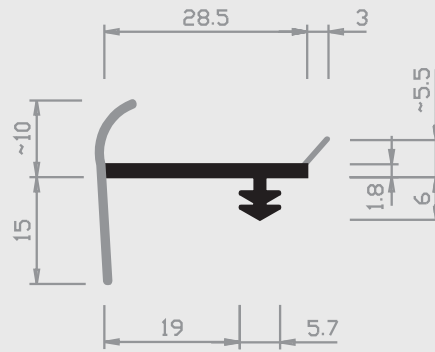

Nr. 14/31 H+W



Nr. 15/2 W

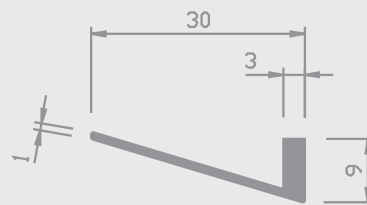

Nr. 13/3 W

= Hart PVC
 = Weich PVC | HH = Halbhart PVC
 = Andere Kunststoffe

04 | DICHTPROFILE

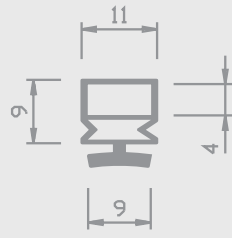

Nr. 30/13b W

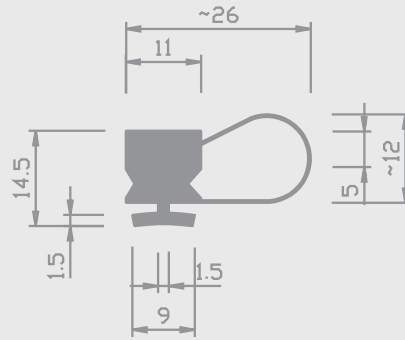

Nr. 30/13a W

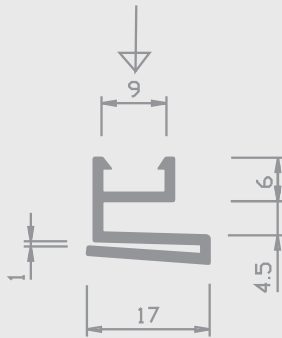

Nr. 29/13 W

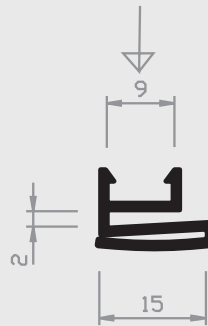

Nr. 30/13 H

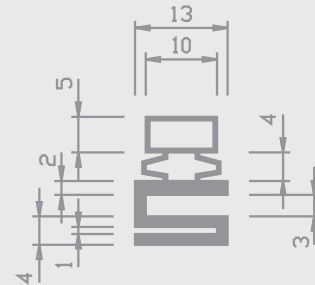

Nr. 30/14 W

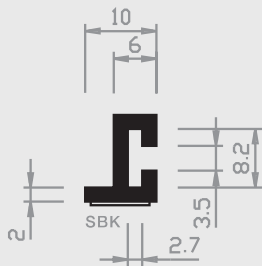

Nr. 24/30 H+SKB

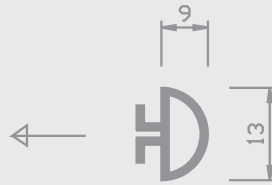

Nr. 8/15 W

= Hart PVC
 = Weich PVC | HH = Halbhart PVC
 = Andere Kunststoffe

04 | DICHTPROFILE



Nr. 8/18 W



Nr. 15/3 W



Nr. 15/25 W



Nr. 16/3 W

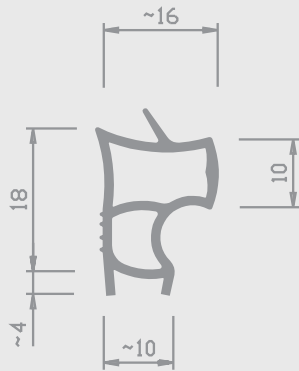

Nr. 16/4 W

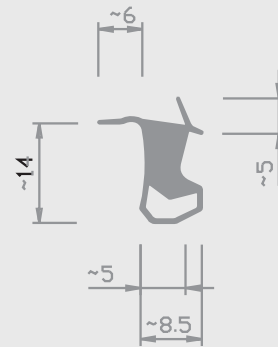

Nr. 16/5 W

= Hart PVC
 = Weich PVC | HH = Halbhart PVC
 = Andere Kunststoffe

04 | DICHTPROFILE

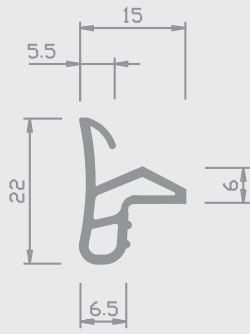

Nr. 15/31 W

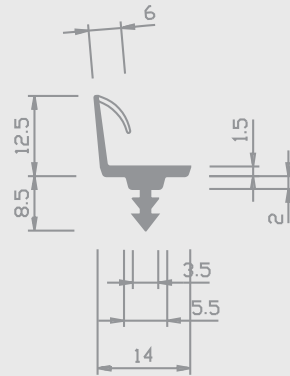

Nr. 19/43 HH+W

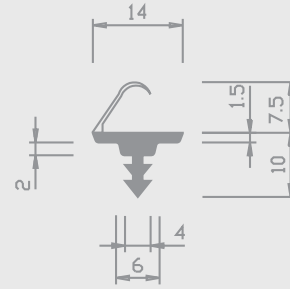

Nr. 19/37 HH+W

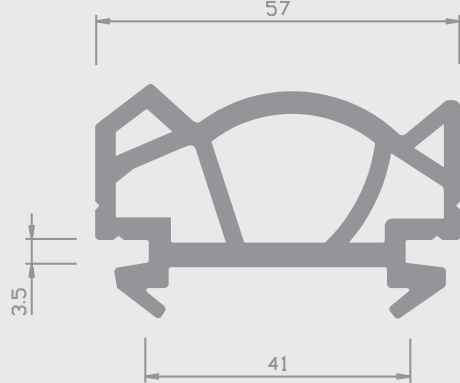

Nr. 32/11 W

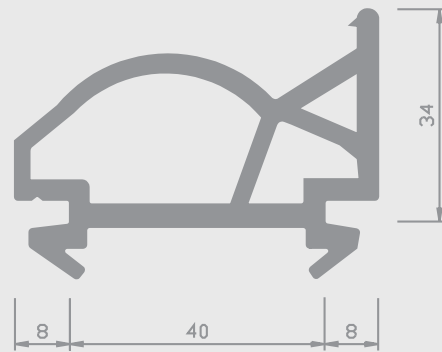

Nr. 32/12 W

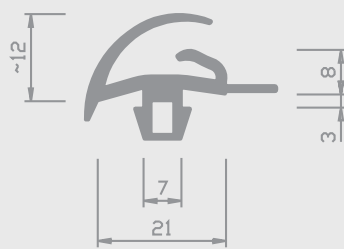

Nr. 32/13 W

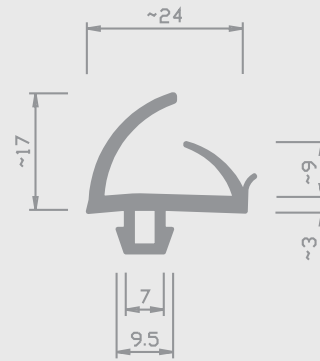

Nr. 32/16 W

= Hart PVC
 = Weich PVC | HH = Halbhart PVC
 = Andere Kunststoffe

04 | DICHTPROFILE

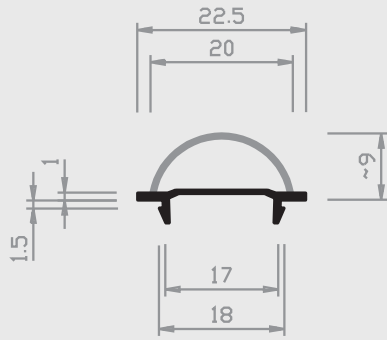

Nr. 7/16 H+W
geschützt

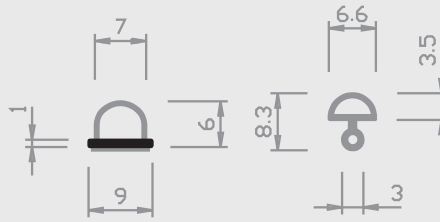

Nr. 7/22 H+W



Nr. 8/12 W

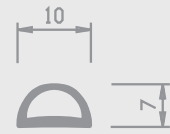

Nr. 8/17 W

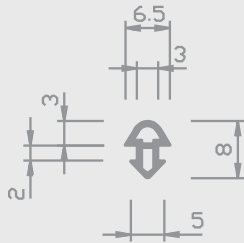

Nr. 8/13 W

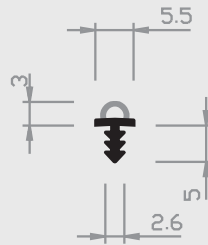

Nr. 24/13 H+W

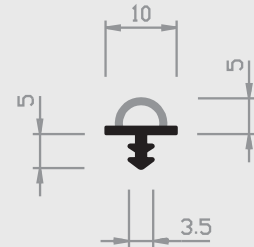

Nr. 24/14 H+W

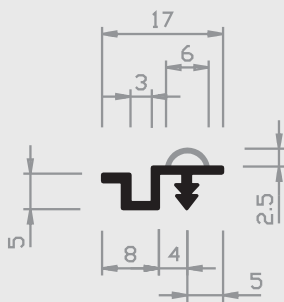

Nr. 26/14 H+W

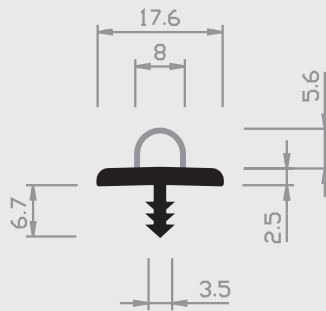

Nr. 20/14 H+W

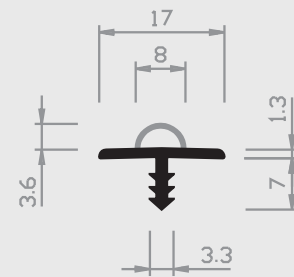

Nr. 20/16 H+W

= Hart PVC
 = Weich PVC | HH = Halbhart PVC
 = Andere Kunststoffe

04 | DICHTPROFILE

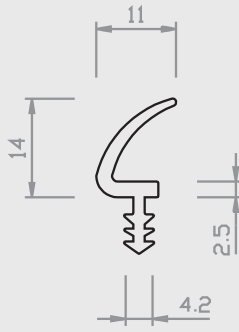

Nr. 12/27 TPE

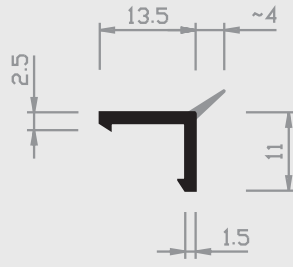

Nr. 26/22 H+W

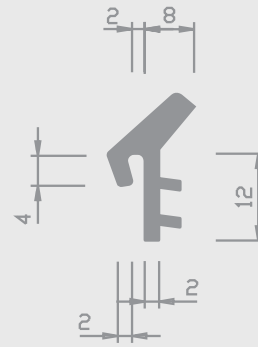

Nr. 13/75 W

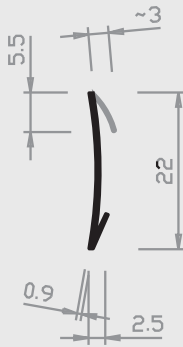

Nr. 20/19 H+W



Nr. 20/19a H+W

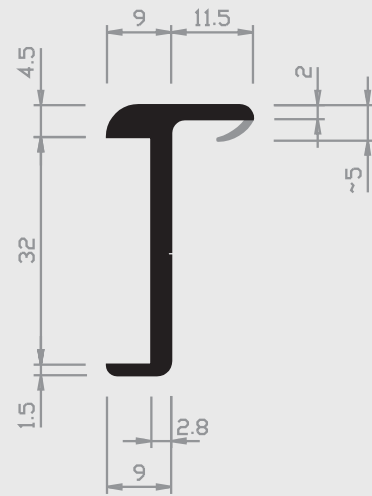

Nr. 15/68 H+W

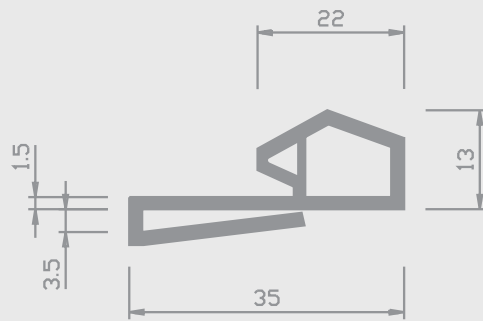

Nr. 30/18 W

= Hart PVC
 = Weich PVC | HH = Halbhart PVC
 = Andere Kunststoffe

04 | DICHTPROFILE

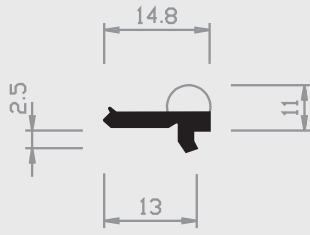

Nr. 26/12 H+W

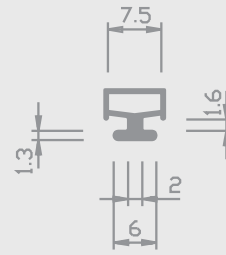

Nr. 24/4 W

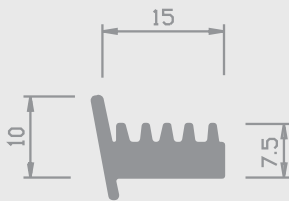

Nr. 33/15 W

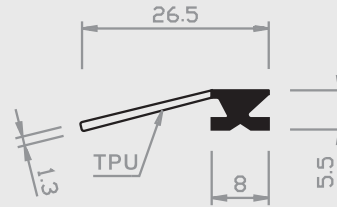

Nr. 18/21a H+TPU

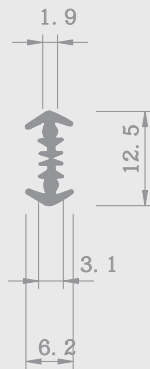

Nr. 08/40 W

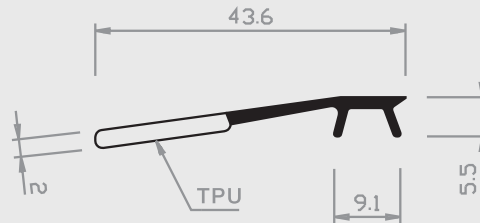

Nr. 19/22 H+TPU

= Hart PVC
 = Weich PVC | HH = Halbhart PVC
 = Andere Kunststoffe

04 | DICHTPROFILE



Nr. 8/17 W

■ = Hart PVC ■ = Weich PVC | HH = Halbhart PVC □ = Andere Kunststoffe