

# 06 | FÜHRUNGSPROFILE

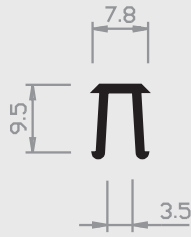

Nr. 12/24 H

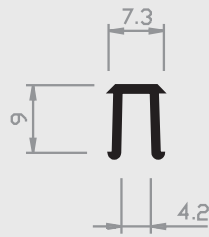

Nr. 21/24 H

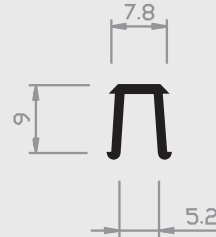

Nr. 25/24 H

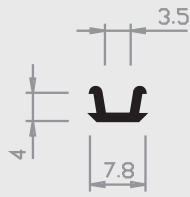

Nr. 22/24 H

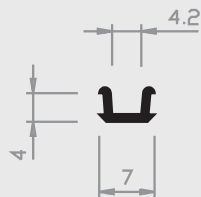

Nr. 11/24 H

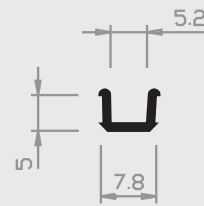

Nr. 15/24 H

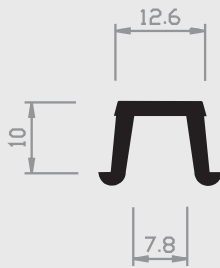

Nr. 13/24 H

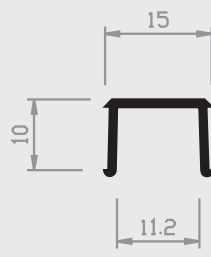

Nr. 18/24 H

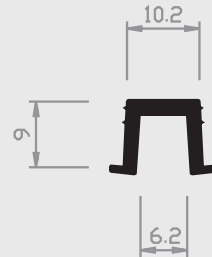

Nr. 19/24 H

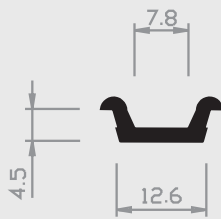

Nr. 23/24 H

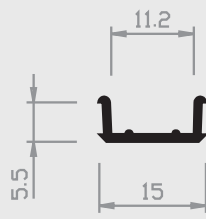

Nr. 24/24 H

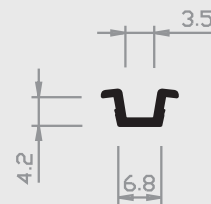

Nr. 8/24 H

■ = Hart PVC

■ = Weich PVC | HH = Halbhart PVC

□ = Andere Kunststoffe

# 06 | FÜHRUNGSPROFILE

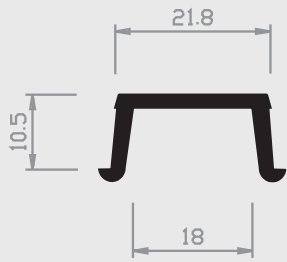

Nr. 27/24 H

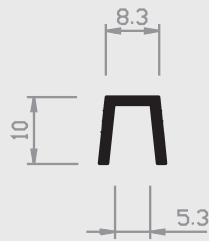

Nr. 11/48 H

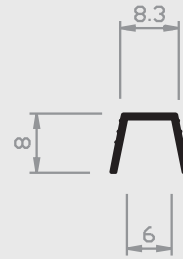

Nr. 16/36 H

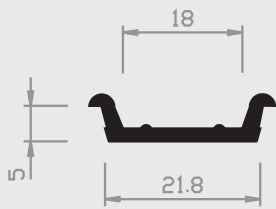

Nr. 26/24 H

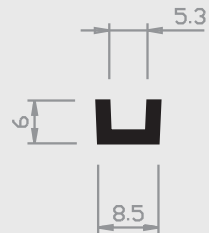

Nr. 11/47 H



Nr. 15/36 H

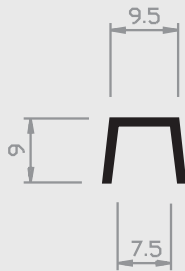

Nr. 14/36 H

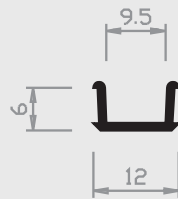

Nr. 30/24 H

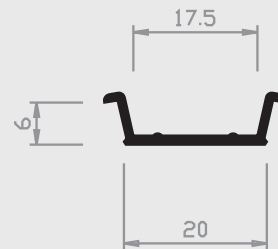

Nr. 28/24 H

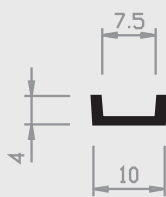

Nr. 17/36 H

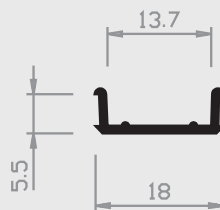

Nr. 14/24a H

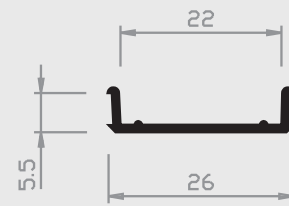

Nr. 29/24 H

= Hart PVC    
  = Weich PVC | HH = Halbhart PVC    
  = Andere Kunststoffe

# 06 | FÜHRUNGSPROFILE

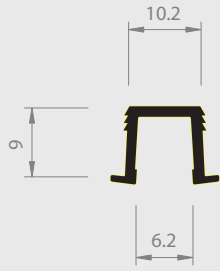

Nr. 20/24 H

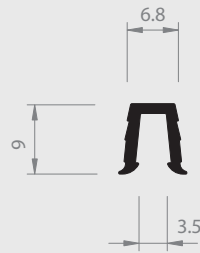

Nr. 32/36 H

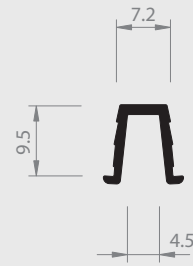

Nr. 24/24 H



Nr. 33/36 H

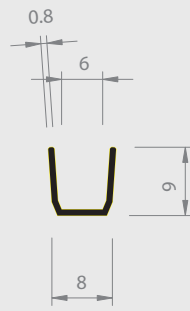

Nr. 10/57 H

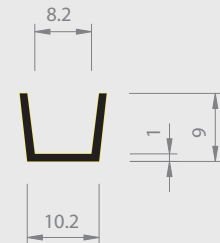

Nr. 36/36 H

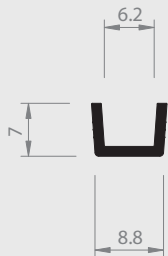

Nr. 11/36 H

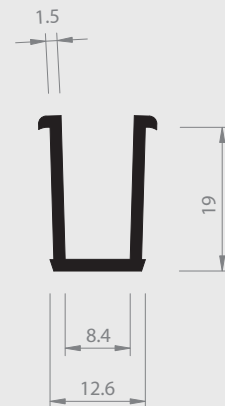

Nr. 33/24 H

■ = Hart PVC

■ = Weich PVC | HH = Halbhart PVC

□ = Andere Kunststoffe

# 06 | FÜHRUNGSPROFILE

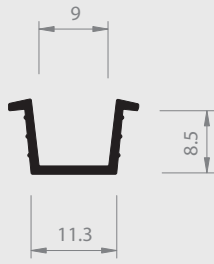

Nr.32/24 H

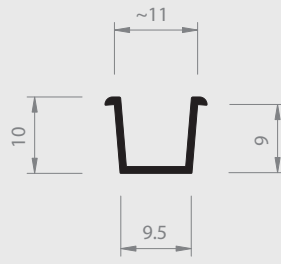

Nr.9/36 H

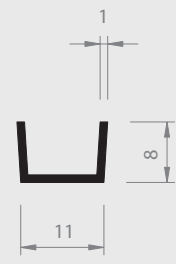

Nr.56/36 H

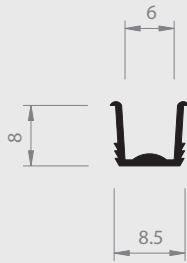

Nr.17/24 H



Nr.6/24 H

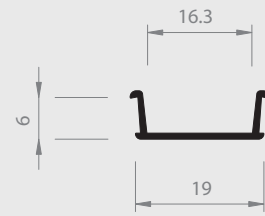

Nr.31/24 H

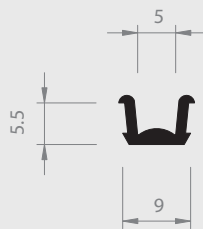

Nr.10/24 H

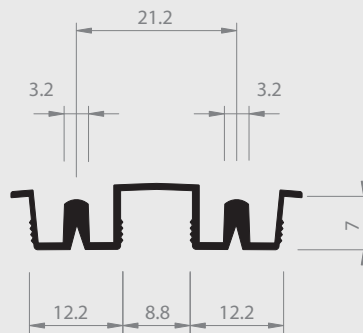

Nr. 20/25 H

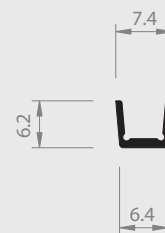

Nr. 40/41 H

= Hart PVC    
  = Weich PVC | HH = Halbhart PVC    
  = Andere Kunststoffe

# 06 | FÜHRUNGSPROFILE

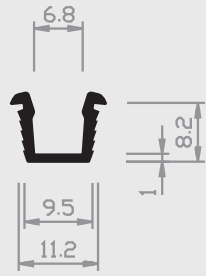

Nr. 19/26 H

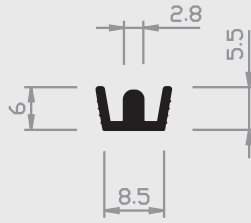

Nr. 18/23 H



Nr. 18/25 H

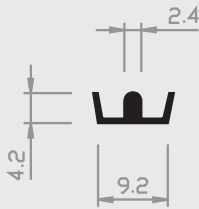

Nr. 18/26 H

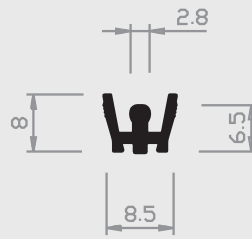

Nr. 19/25 H



Nr. 7/24 H



Nr. 6/23 H



Nr. 6/22 PP

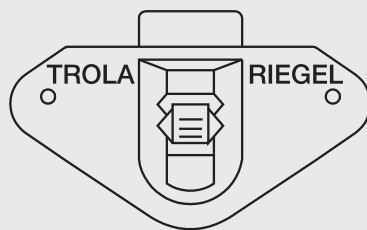

Nr. 90/01

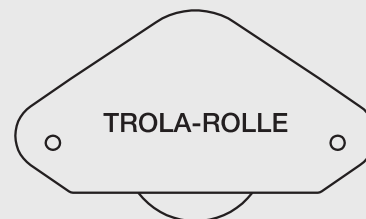

Nr. 90/02

= Hart PVC    
  = Weich PVC | HH = Halbhart PVC    
  = Andere Kunststoffe

# 06 | FÜHRUNGSPROFILE

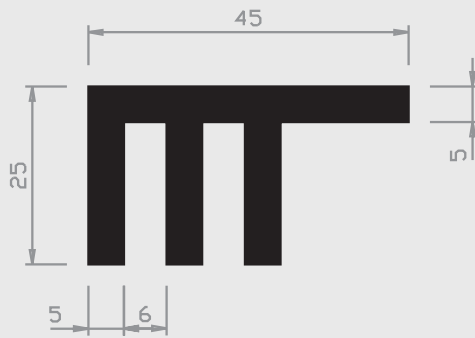

Nr. 9/21 H

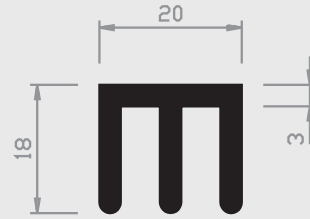

Nr. 16/27 H

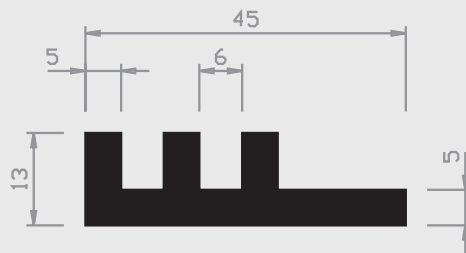

Nr. 9/22 H

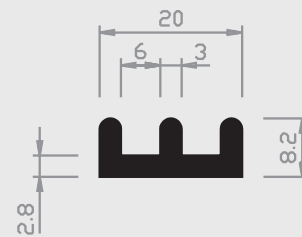

Nr. 16/26 H

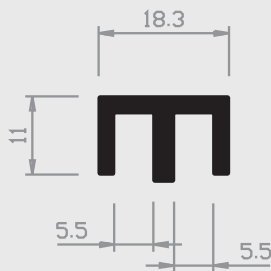

Nr. 11/27 H

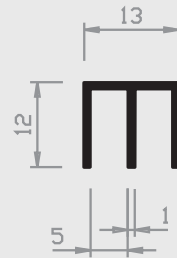

Nr. 15/27 H

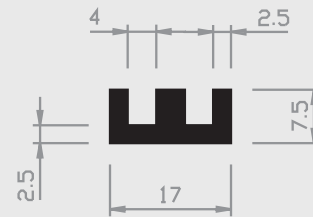

Nr. 12/26 H

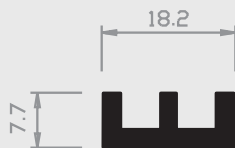

Nr. 11/26 H



Nr. 15/26 H

= Hart PVC    
  = Weich PVC | HH = Halbhart PVC    
  = Andere Kunststoffe

# 06 | FÜHRUNGSPROFILE

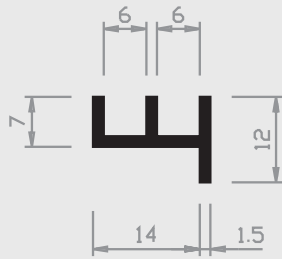

Nr. 25/37 H

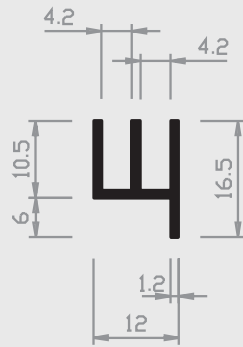

Nr. 22/37 H

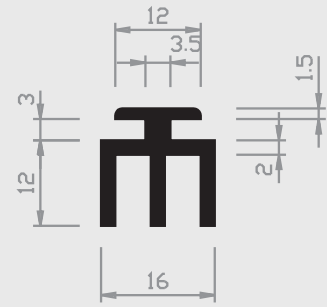

Nr. 13/21 H

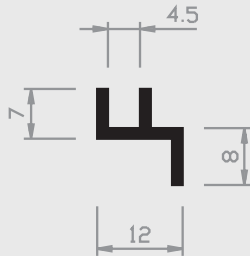

Nr. 24/37 H

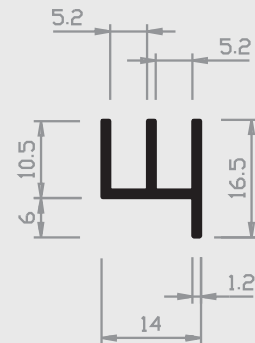

Nr. 23/37 H

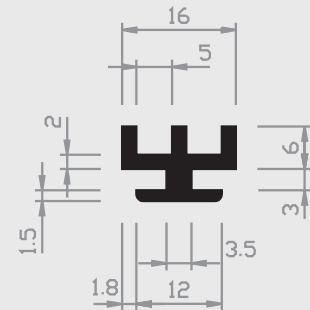

Nr. 13/22 H

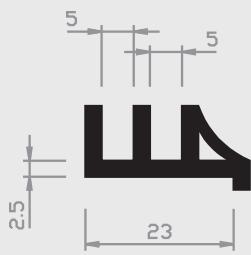

Nr. 10/23 H

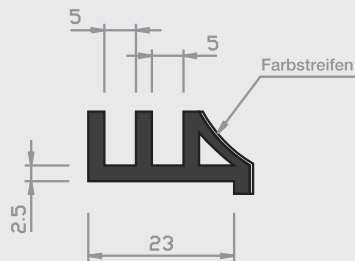

Nr. 20/23 H  
zweifarbig

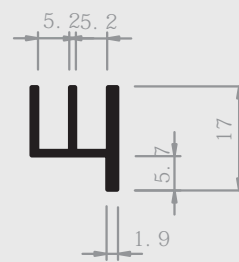

Nr. 23/37a H



Nr. 10/25 H  
FE 2

= Hart PVC
  = Weich PVC | HH = Halbhart PVC
  = Andere Kunststoffe

# 06 | FÜHRUNGSPROFILE

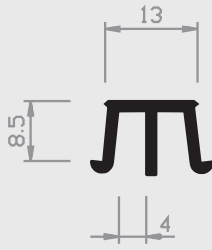

Nr. 10/21 H

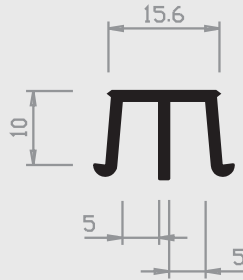

Nr. 11/21 H

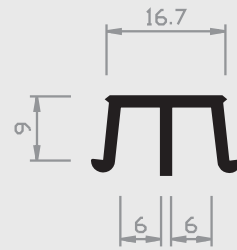

Nr. 12/21 H

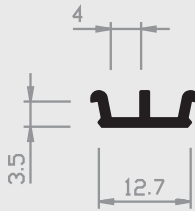

Nr. 10/22 H

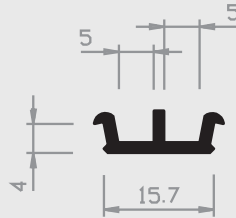

Nr. 11/22 H

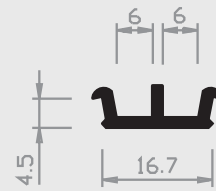

Nr. 12/22 H

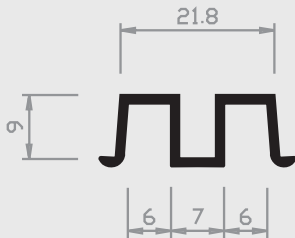

Nr. 11/46 H

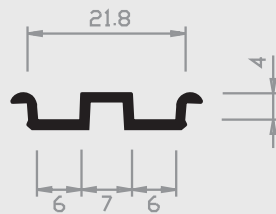

Nr. 11/45 H

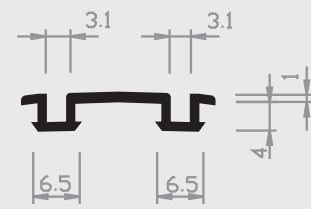

Nr. 33/38 H

= Hart PVC    
  = Weich PVC | HH = Halbhart PVC    
  = Andere Kunststoffe



# 06 | FÜHRUNGSPROFILE

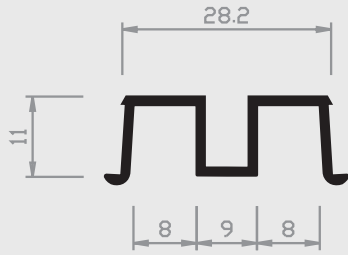

Nr. 12/46 H

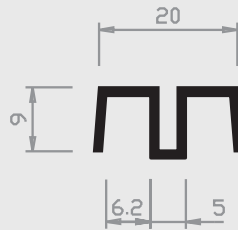

Nr. 10/27 H

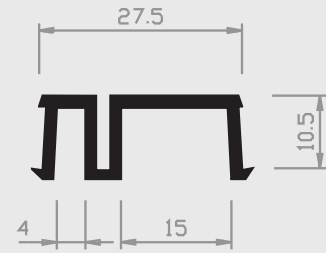

Nr. 17/46 H

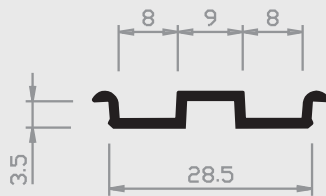

Nr. 13/46 H

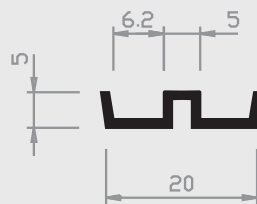

Nr. 10/26 H

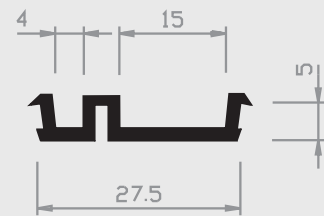

Nr. 16/46 H

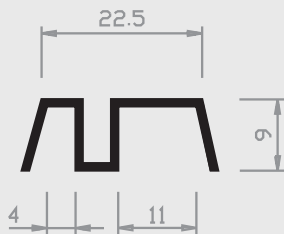

Nr. 13/26 H

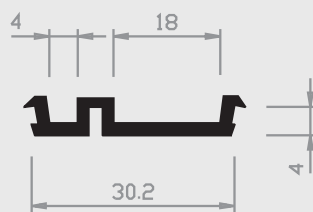

Nr. 18/46 H

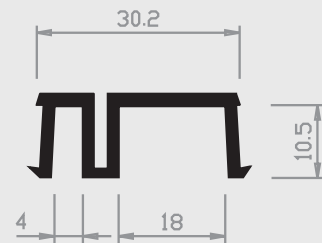

Nr. 19/46 H

= Hart PVC    
  = Weich PVC | HH = Halbhart PVC    
  = Andere Kunststoffe

# 06 | FÜHRUNGSPROFILE



Nr. 3/24 H



Nr. 03/25 H

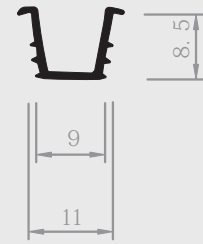

Nr. 16/24 H

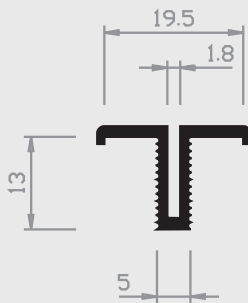

Nr. 15/37 H

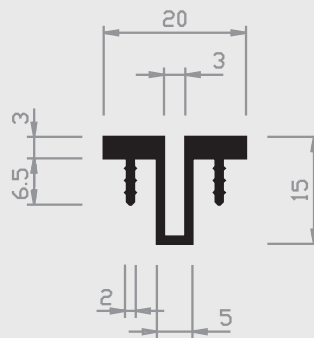

Nr. 16/37 H

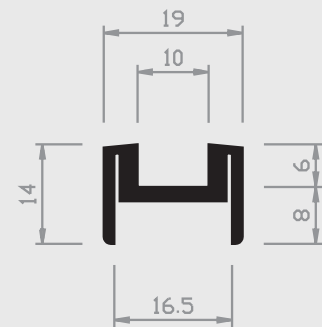

Nr. 16/59 H

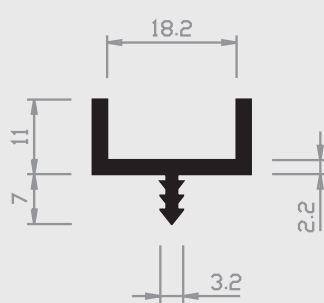

Nr. 17/60 H

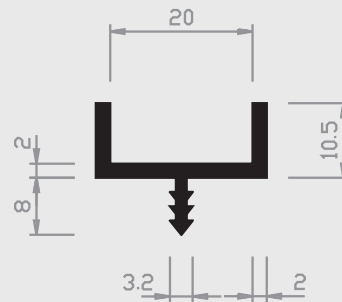

Nr. 17/59 H

= Hart PVC    
  = Weich PVC | HH = Halbhart PVC    
  = Andere Kunststoffe

# 06 | FÜHRUNGSPROFILE

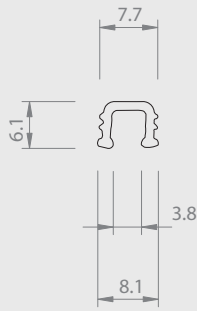

Nr. 6/30 PP

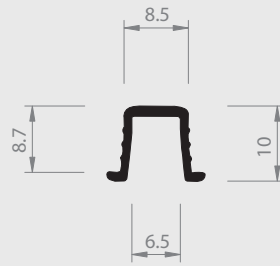

Nr. 19/56 H

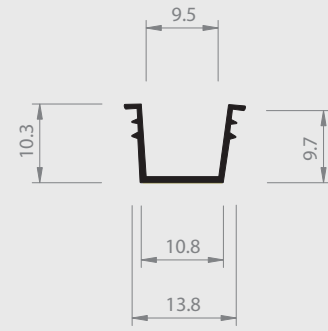

Nr. 34/24 H

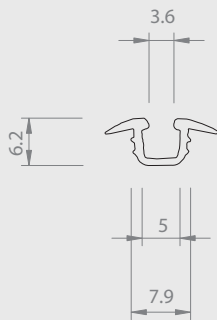

Nr. 6/29 PP

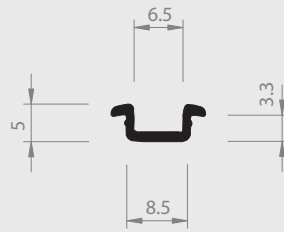

Nr. 19/55 H

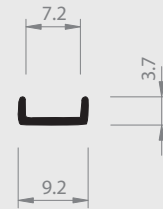

Nr. 31/01 H

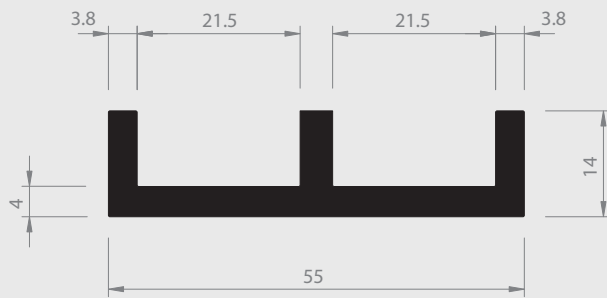

Nr. 20/27 H

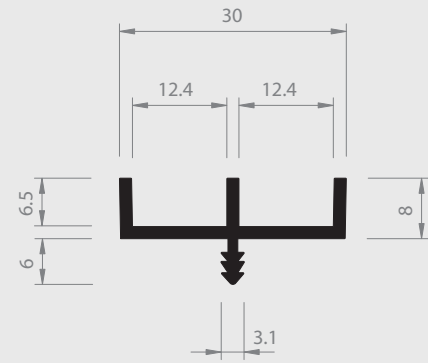

Nr. 16/21 H

= Hart PVC    
  = Weich PVC | HH = Halbhart PVC    
  = Andere Kunststoffe

# 06 | FÜHRUNGSPROFILE

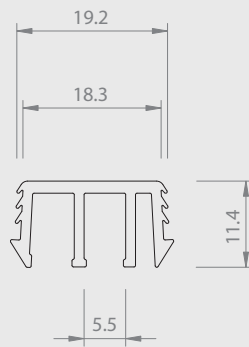

Nr.11/65 ABS

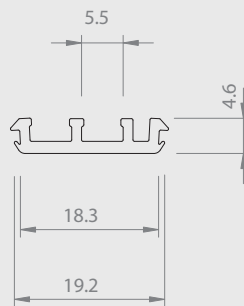

Nr.11/66 ABS

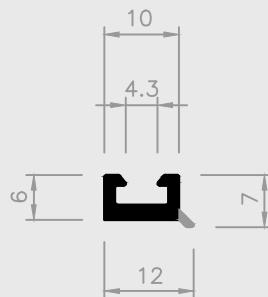

Nr. 36/33 H+W

■ = Hart PVC   ■ = Weich PVC | HH = Halbhart PVC   □ = Andere Kunststoffe