

03 | BAUPROFILE

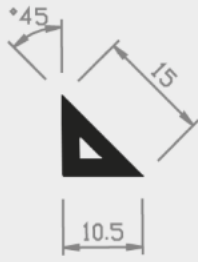

Nr. 61/52 H

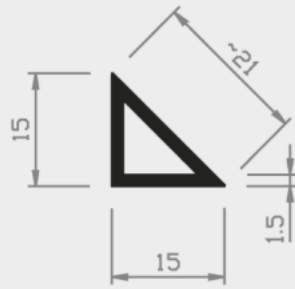

Nr. 61/48 H

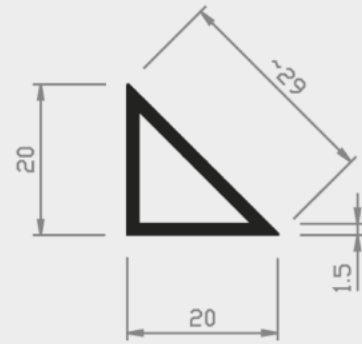

Nr. 61/49 H

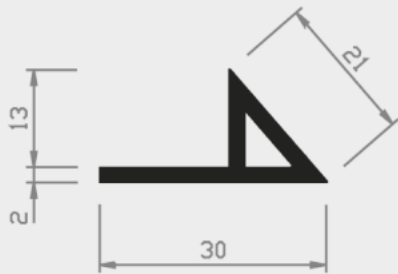

Nr. 61/55 H

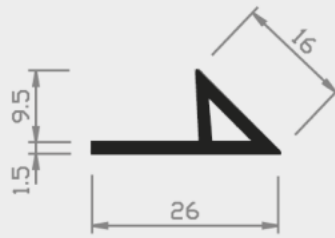

Nr. 61/56 H

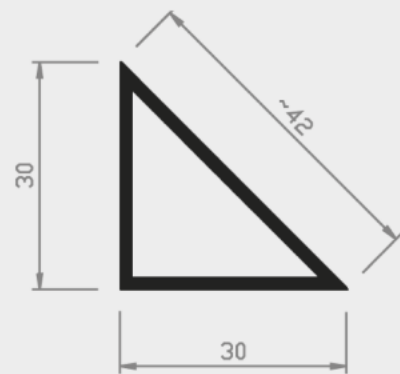

Nr. 61/62 H

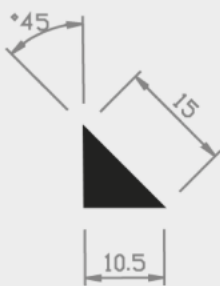

Nr. 60/52 H

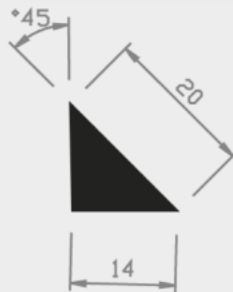

Nr. 60/51 H

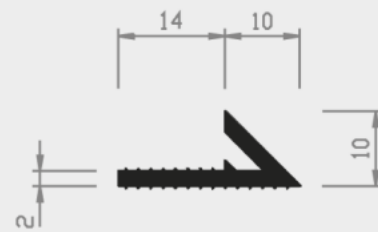

Nr. 60/57 H

= Hart PVC
 = Weich PVC | HH = Halbhart PVC
 = Andere Kunststoffe

03 | BAUPROFILE

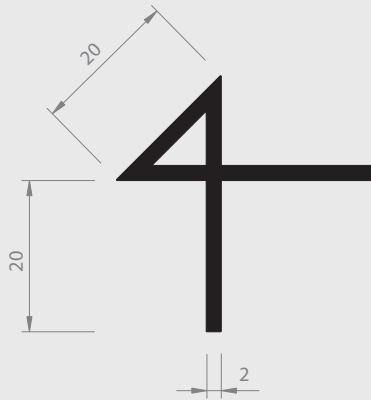

Nr.61/60 H

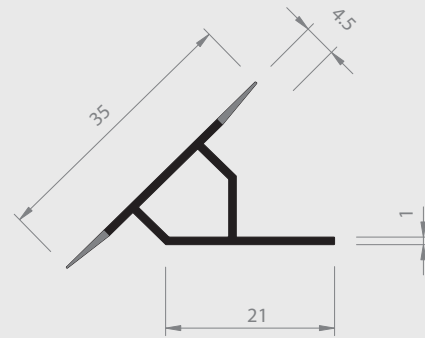

Nr.61/59 H+W

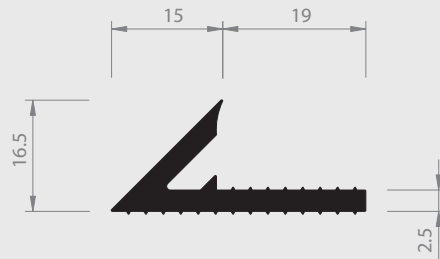

Nr.60/59 H



Nr.60/46 W 80mm
Nr.60/47 W 120mm

■ = Hart PVC

■ = Weich PVC | HH = Halbhart PVC

□ = Andere Kunststoffe

03 | BAUPROFILE

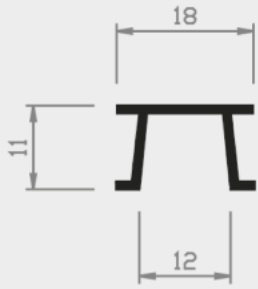

Nr. 60/49 H

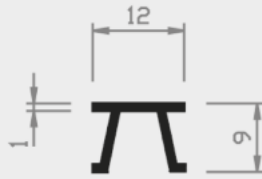

Nr. 60/48 H

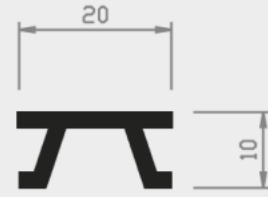

Nr. 60/50 H

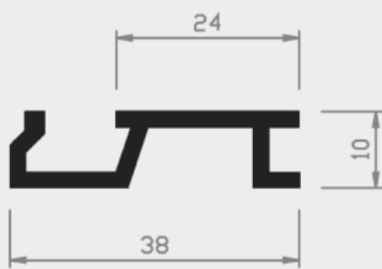

Nr. 60/56 H

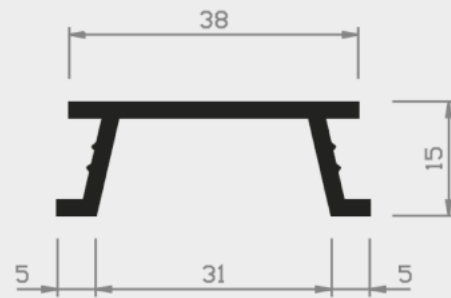

Nr. 64/50 H

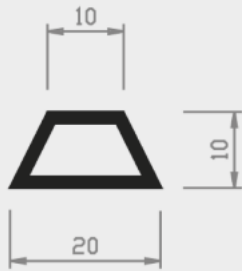

Nr. 61/50 H

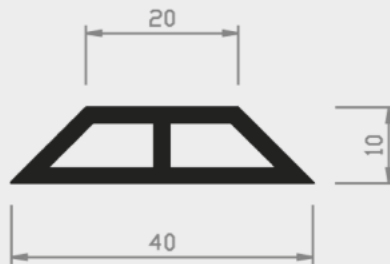

Nr. 61/53 H

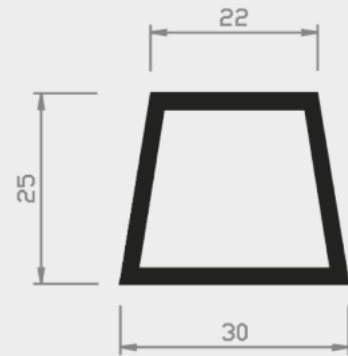

Nr. 61/47 H

= Hart PVC
 = Weich PVC | HH = Halbhart PVC
 = Andere Kunststoffe

03 | BAUPROFILE

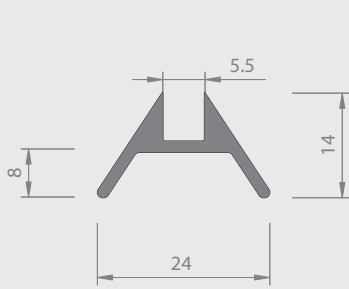

Nr.61/57 W

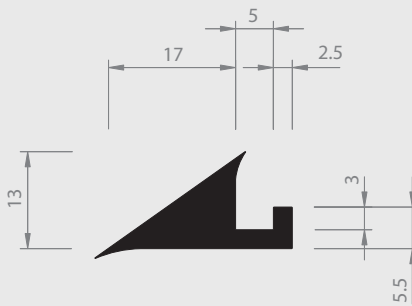

Nr.60/54 H

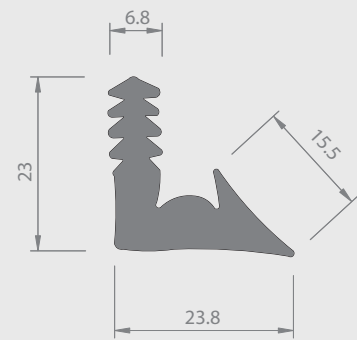

Nr. 62/57 W

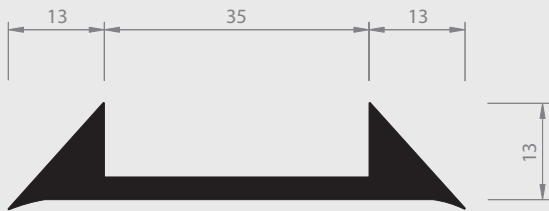

Nr.60/55 H

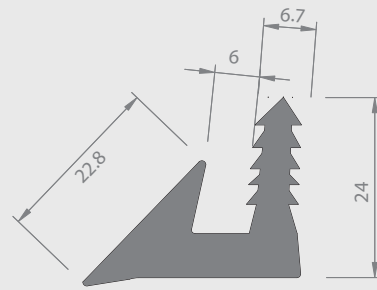

Nr. 62/58 W

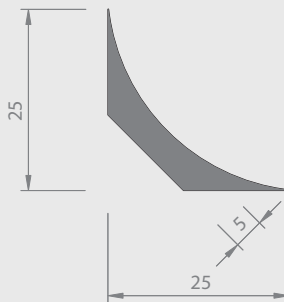

Nr.40/25 W

= Hart PVC
 = Weich PVC | HH = Halbhart PVC
 = Andere Kunststoffe

03 | BAUPROFILE

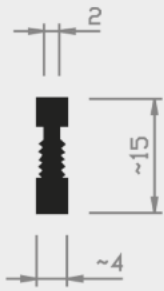

Nr. 60/32 H

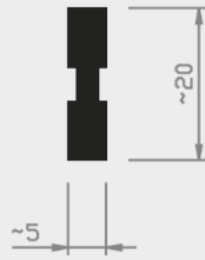

Nr. 60/34 H

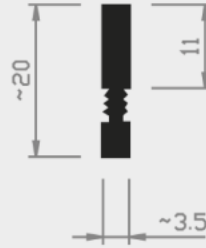

Nr. 60/40 H

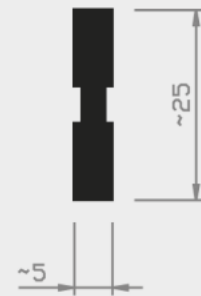

Nr. 60/42 H

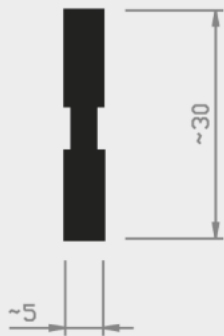

Nr. 60/43 H

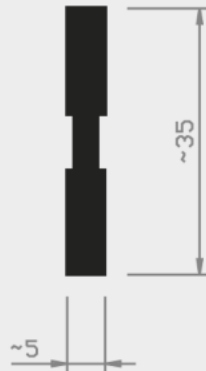

Nr. 60/44 H



Nr. 40/4 H

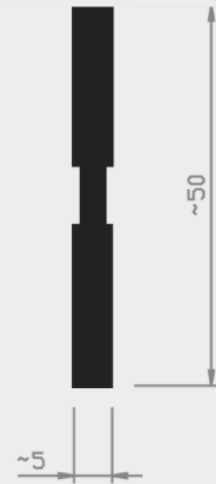

Nr. 60/45 H



Nr. 60/16 HH

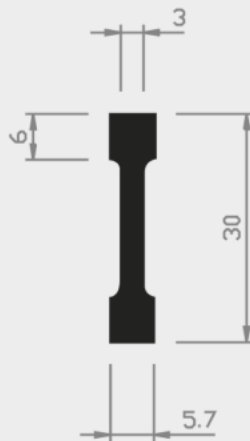

Nr. 14/42 H

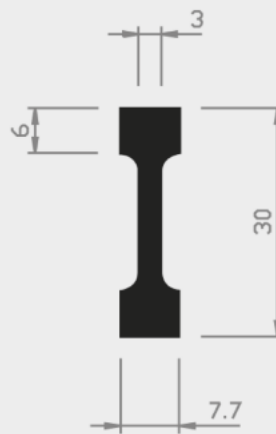

Nr. 15/42 H

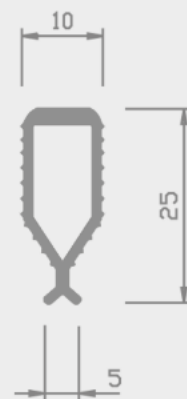

Nr. 60/41 HH

■ = Hart PVC

■ = Weich PVC | HH = Halbhart PVC

□ = Andere Kunststoffe

03 | BAUPROFILE

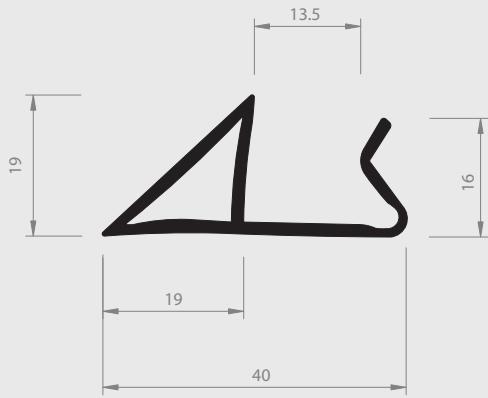

Nr. 61/66 H

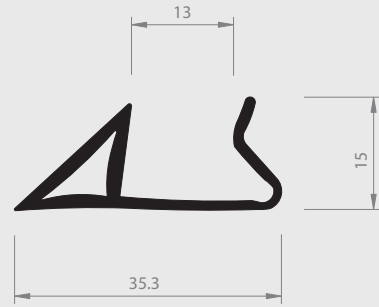

Nr. 61/67 H

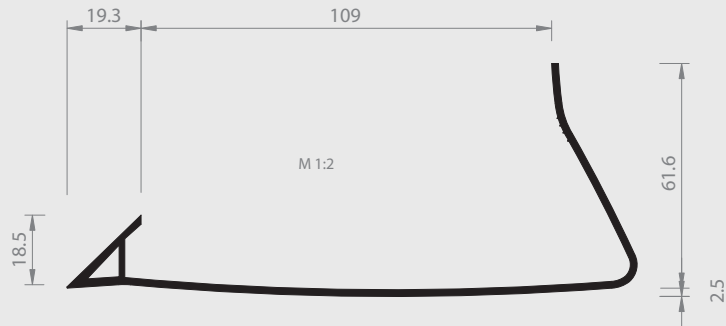

Nr. 61/65 H



Nr. 61/80 H

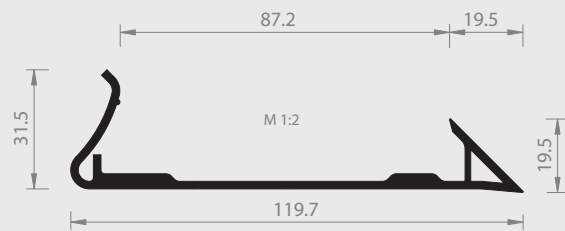

Nr. 61/79 H

= Hart PVC
 = Weich PVC | HH = Halbhart PVC
 = Andere Kunststoffe

03 | BAUPROFILE

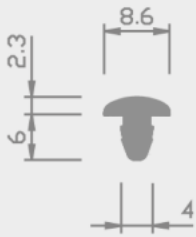

Nr. 63/84 W
4+5 mm

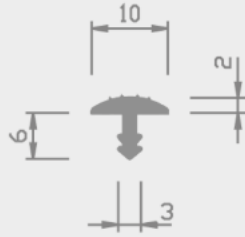

Nr. 10/82 W 3 mm
Nr. 10/82a W 4,5 mm

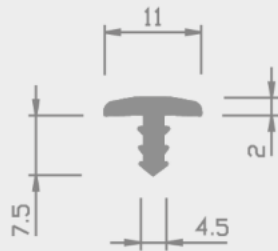

Nr. 65/84 W

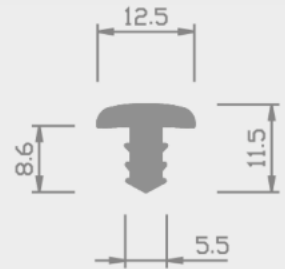

Nr. 65/84a W

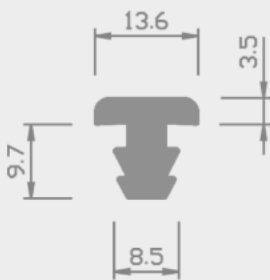

Nr. 60/84a W

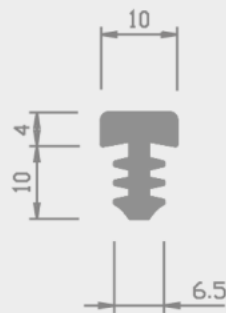

Nr. 60/87 W

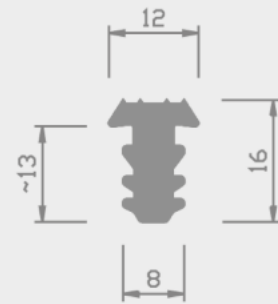

Nr. 61/84 W

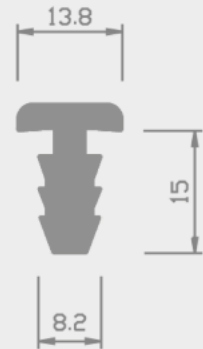

Nr. 60/84 W

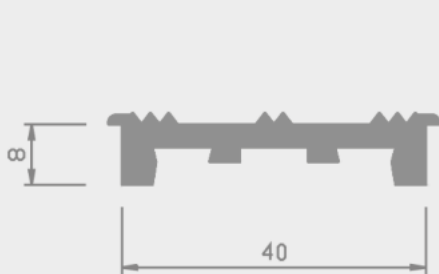

Nr. 62/82 W

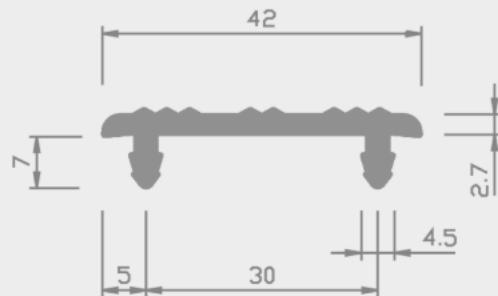

Nr. 63/82 W



Nr. 10/81 W

■ = Hart PVC

■ = Weich PVC | HH = Halbhart PVC

□ = Andere Kunststoffe

03 | BAUPROFILE

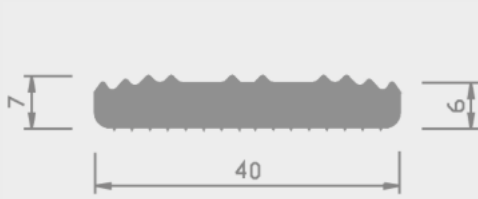

Nr. 60/82 W

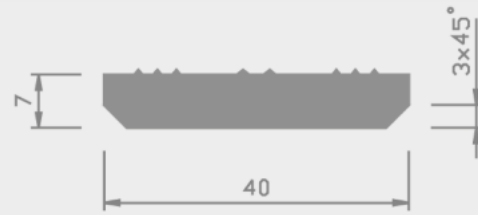

Nr. 64/82 W

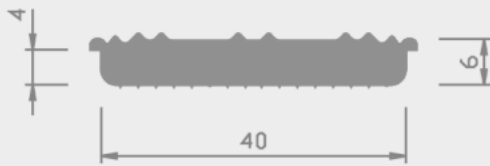

Nr. 61/82 W

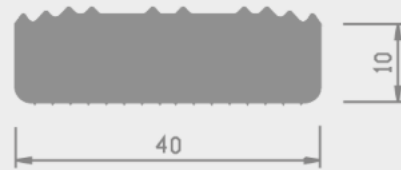

Nr. 65/82 W

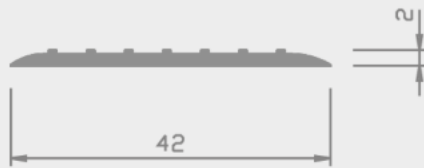

Nr. 45/18 W

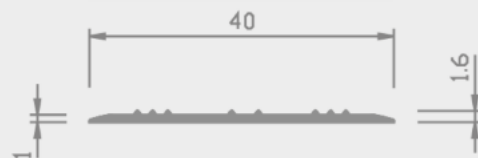

Nr. 66/82 W
selbstklebend

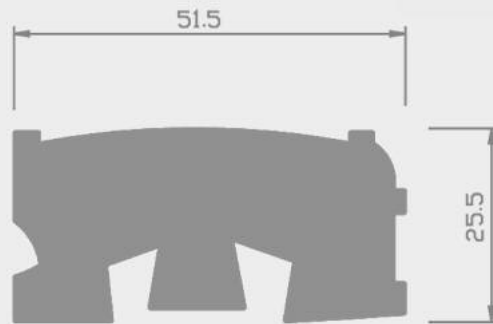

Nr. 66/80 HH

= Hart PVC
 = Weich PVC | HH = Halbhart PVC
 = Andere Kunststoffe

03 | BAUPROFILE



Nr. 55/32 H

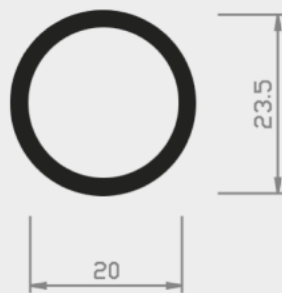

Nr. 55/34 H
gerauht

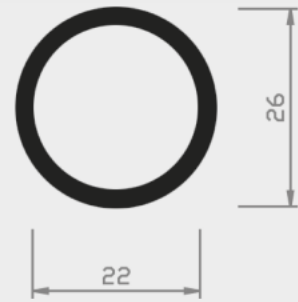

Nr. 55/35 H
gerauht

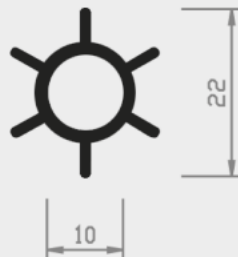

Nr. 60/58 H

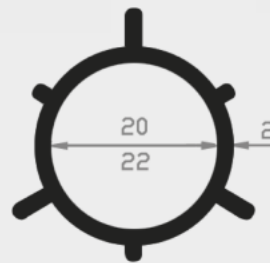

Nr. 60/58 H
22 mm
20 mm

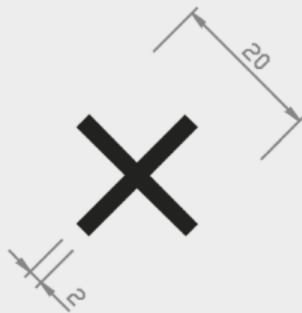

Nr. 60/53 H

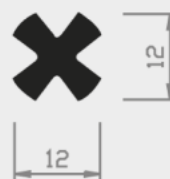

Nr. 62/53 H

= Hart PVC
 = Weich PVC | HH = Halbhart PVC
 = Andere Kunststoffe