

05 | BODENLEGERPROFILE

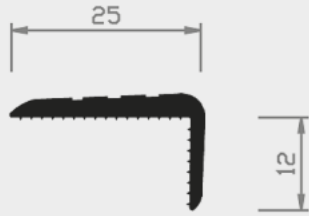

Nr. 40/17a H

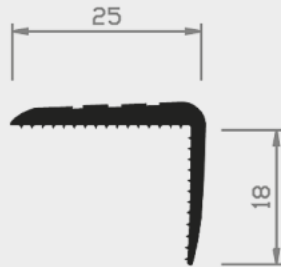

Nr. 40/17 H

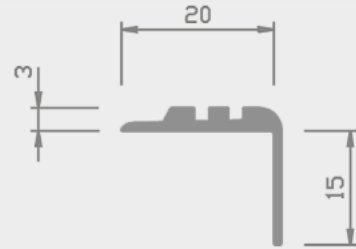

Nr. 40/9 W

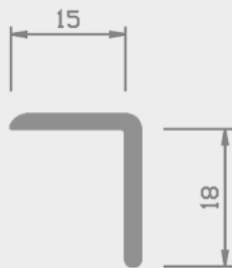

Nr. 40/18 W

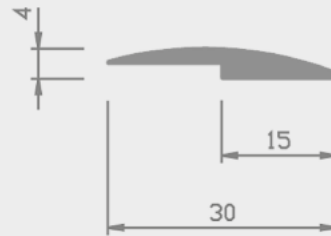

Nr. 40/33 W

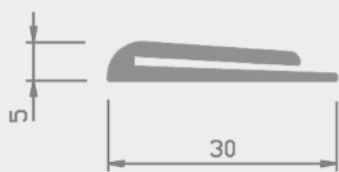

Nr. 40/34 W

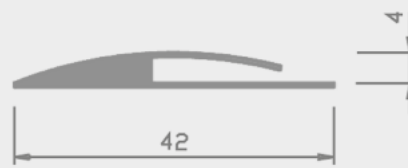

Nr. 40/35 W

= Hart PVC
 = Weich PVC | HH = Halbhart PVC
 = Andere Kunststoffe

05 | BODENLEGERPROFILE

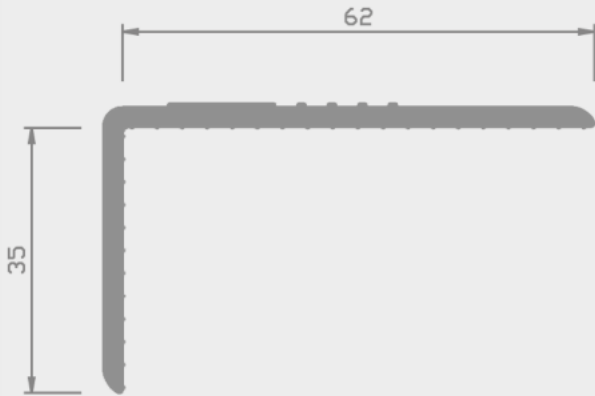

Nr. 40/21 W

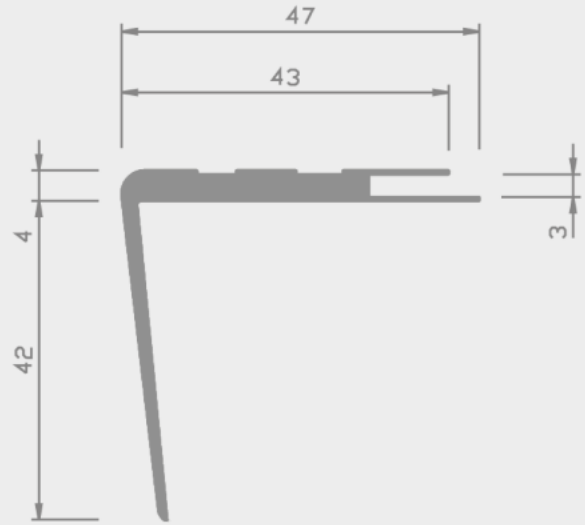

Nr. 40/7 W

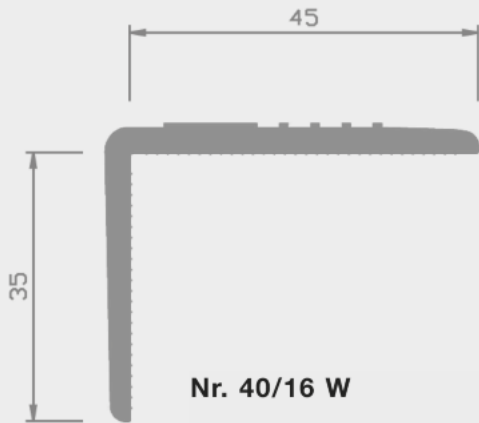

Nr. 40/16 W

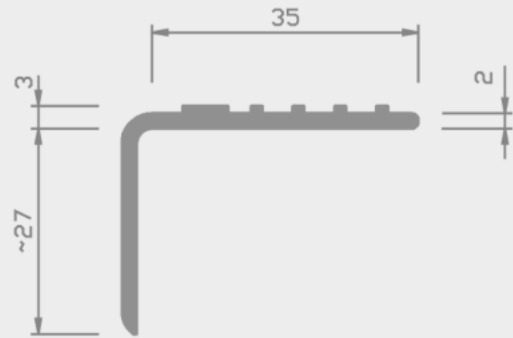

Nr. 40/10 W

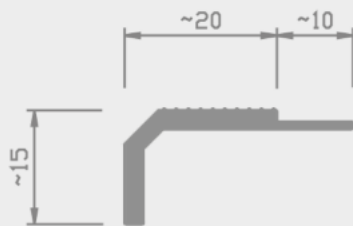

Nr. 40/8 W

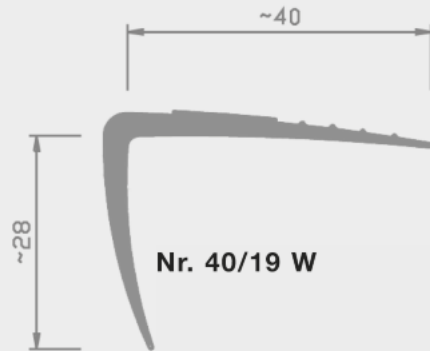

Nr. 40/19 W

= Hart PVC
 = Weich PVC | HH = Halbhart PVC
 = Andere Kunststoffe

05 | BODENLEGERPROFILE

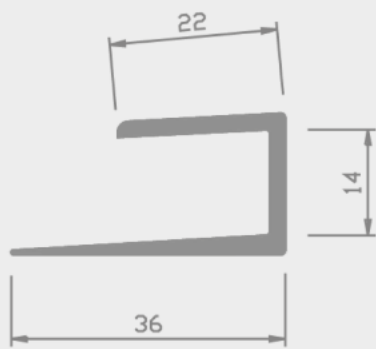
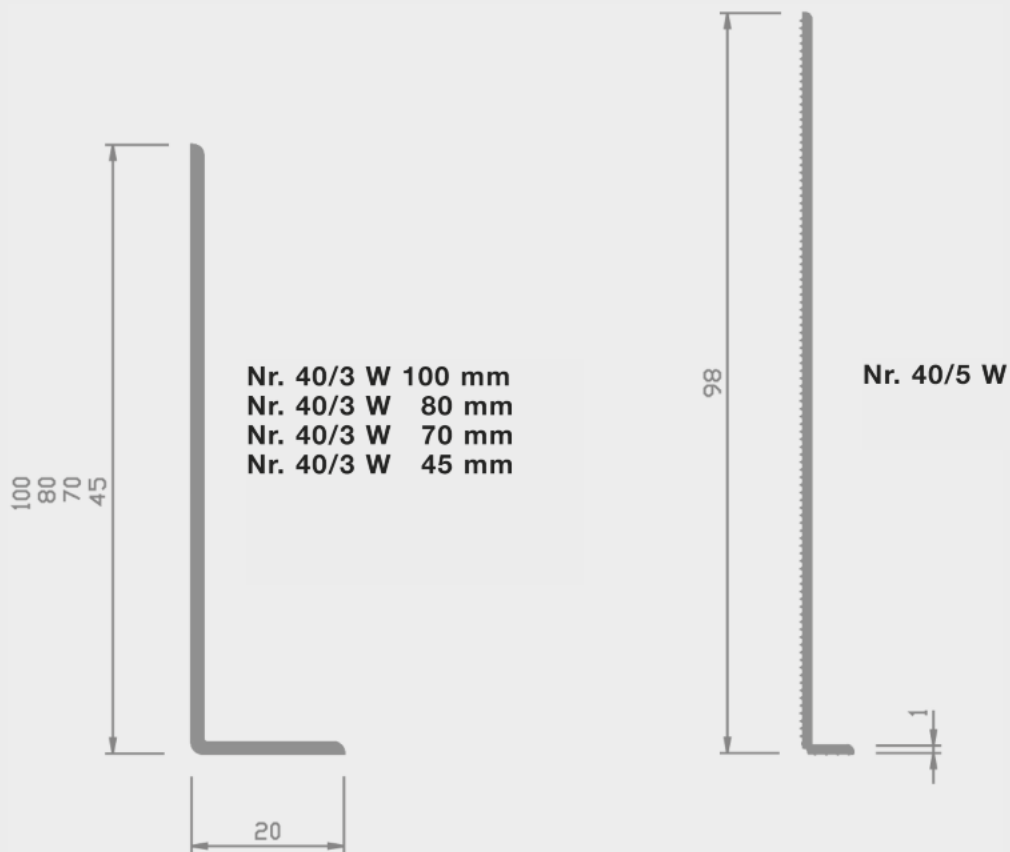

Nr. 11/76 HH

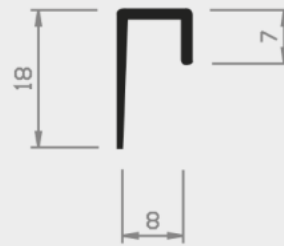

Nr. 40/55 H

■ = Hart PVC ■ = Weich PVC | HH = Halbhart PVC □ = Andere Kunststoffe

05 | BODENLEGERPROFILE

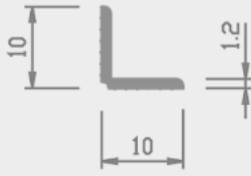

Nr. 40/11 W

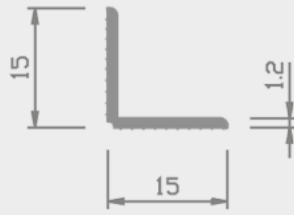

Nr. 40/12 W

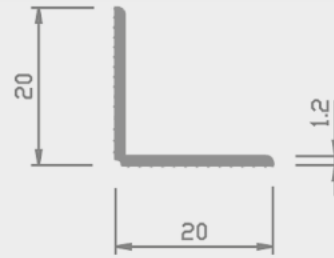

Nr. 40/13 W

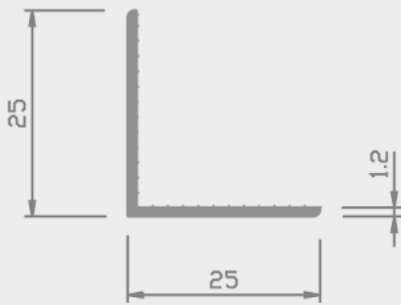

Nr. 40/15 W

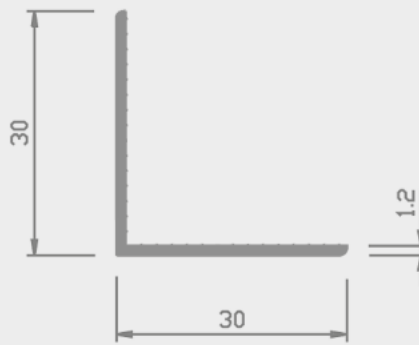

Nr. 40/14 W

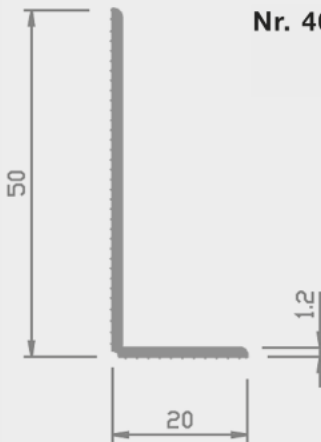

Nr. 40/2 W

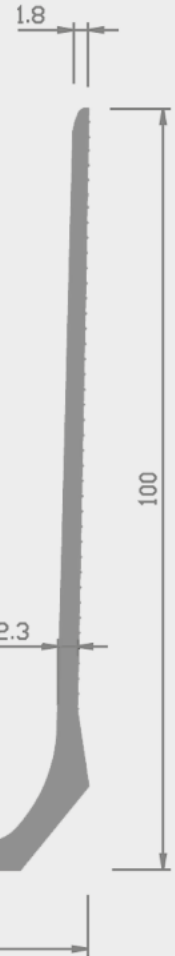

Nr. 40/30 HH

= Hart PVC
 = Weich PVC | HH = Halbhart PVC
 = Andere Kunststoffe

05 | BODENLEGERPROFILE

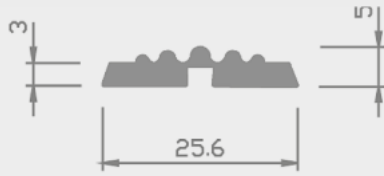

Nr. 11/84 W

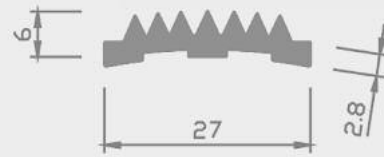

Nr. 11/85 W geschützt

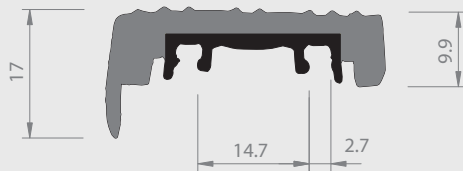

Nr. 27/93 H+W

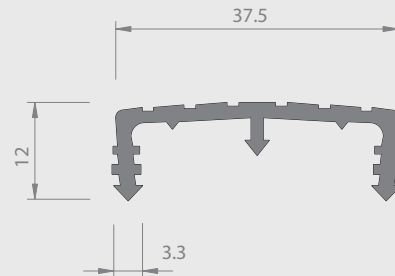

Nr. 45/19 W

= Hart PVC
 = Weich PVC | HH = Halbhart PVC
 = Andere Kunststoffe