

24 | U - PROFILE

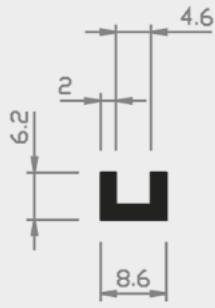

Nr. 43/36 H



Nr. 31/36 H

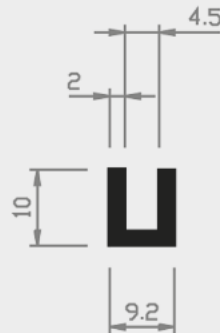

Nr. 27/36 H

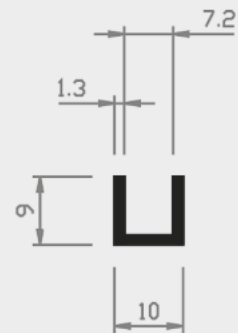

Nr. 10/36 H

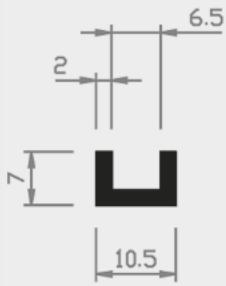

Nr. 30/36 H

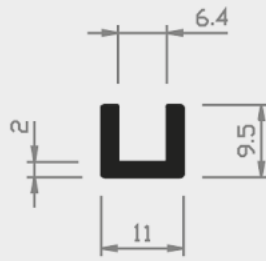

Nr. 13/36 H



Nr. 59/36 H



Nr. 13/36a H

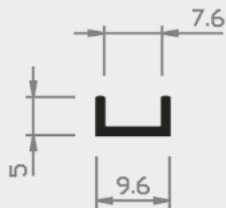

Nr. 38/36 H

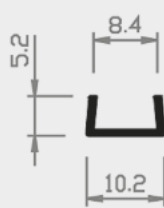

Nr. 19/36 H



Nr. 16/14 W

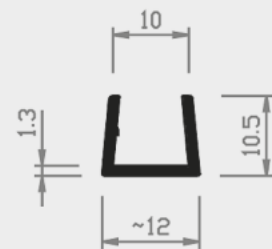

Nr. 40/36 H

■ = Hart PVC

■ = Weich PVC | HH = Halbhart PVC

□ = Andere Kunststoffe

24 | U - PROFILE

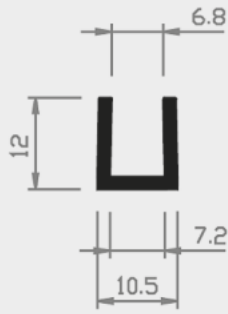

Nr. 5/36 H

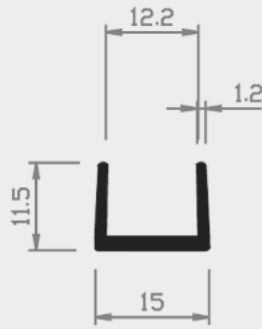

Nr. 21/36 H

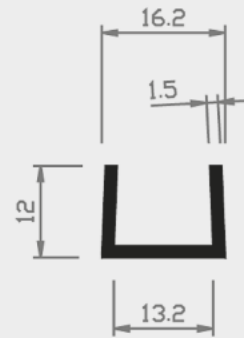

Nr. 23/36 H

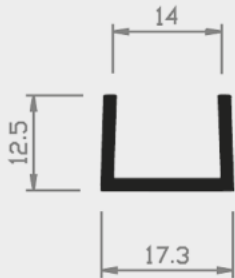

Nr. 23/36a H

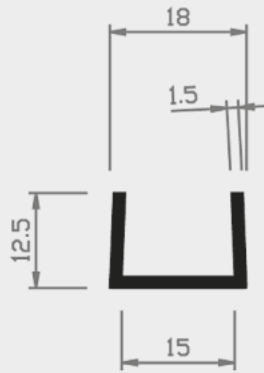

Nr. 26/36 H

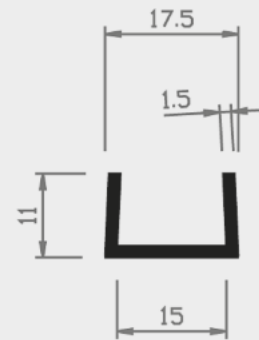

Nr. 22/36 H

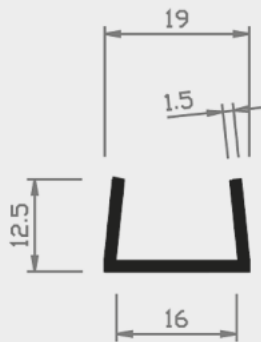

Nr. 24/36 H

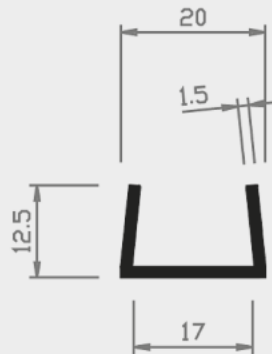

Nr. 24/36a H

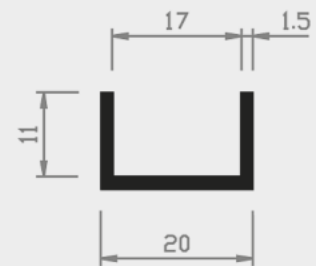

Nr. 24/36b H

■ = Hart PVC

■ = Weich PVC | HH = Halbhart PVC

□ = Andere Kunststoffe

24 | U - PROFILE

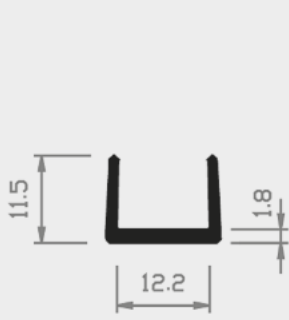

Nr. 21/36a H

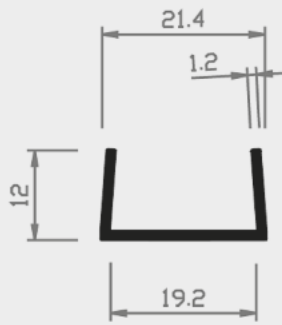

Nr. 48/36 H

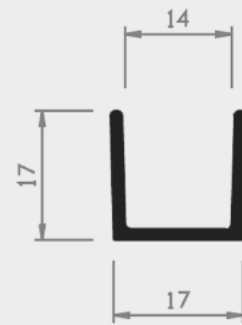

Nr. 29/36 H

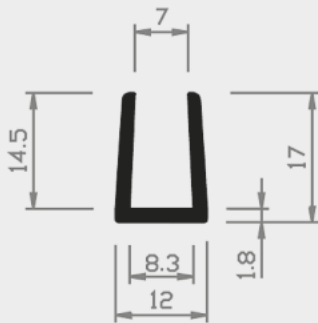

Nr. 34/36 H

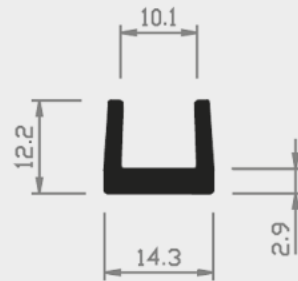

Nr. 55/36 H

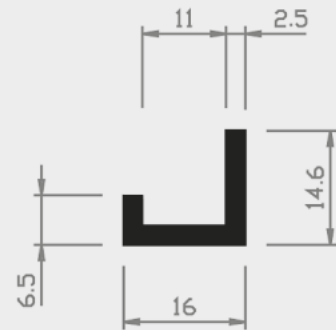

Nr. 18/37 H

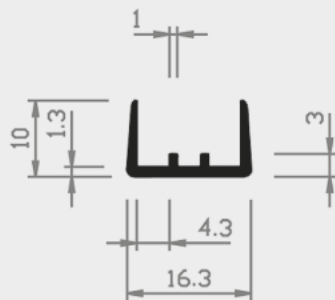

Nr. 41/36 H

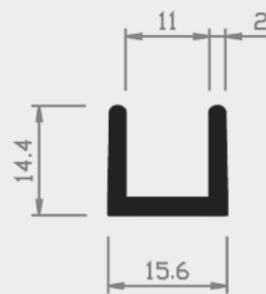

Nr. 28/36 H

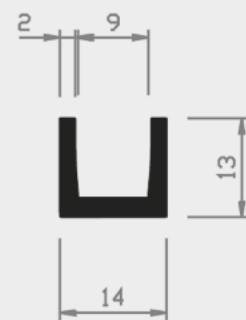

Nr. 18/36 H

■ = Hart PVC

■ = Weich PVC | HH = Halbhart PVC

□ = Andere Kunststoffe

24 | U - PROFILE

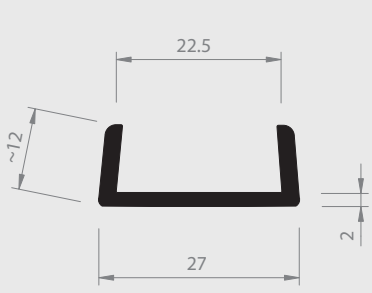

Nr.46/36 H

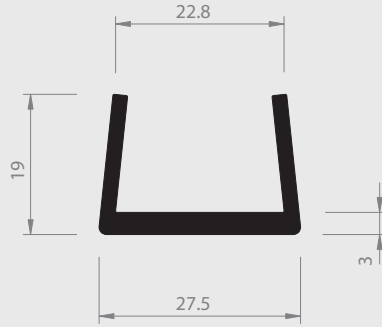

Nr.20/36 H

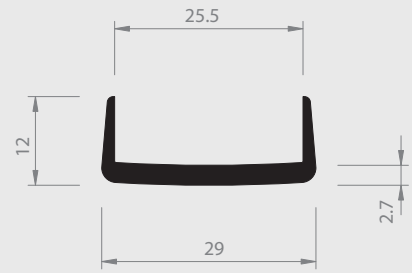

Nr.35/36 H

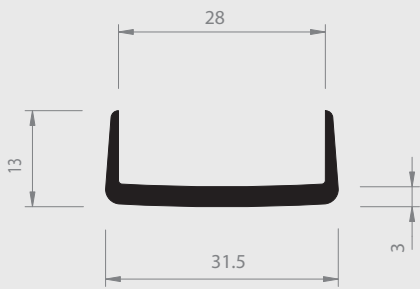

Nr.35/36a H

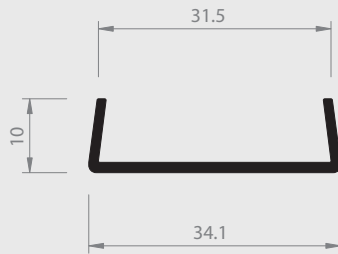

Nr.25/36 H

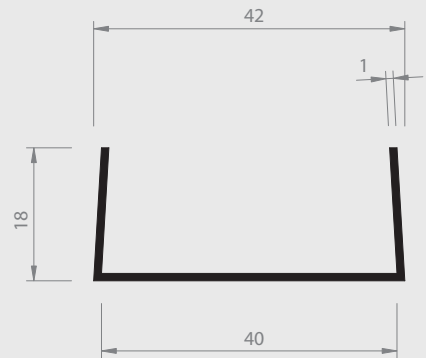

Nr.50/36 H

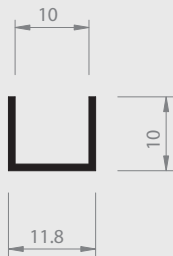

Nr. 31/37 H

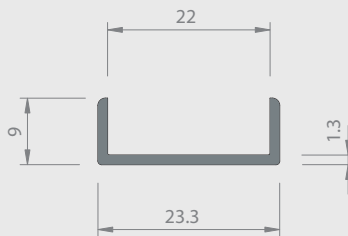

Nr.42/36 W

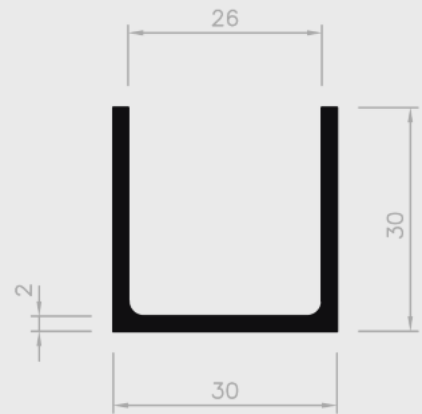

Nr. 63/36 H

■ = Hart PVC

■ = Weich PVC | HH = Halbhart PVC

□ = Andere Kunststoffe

24 | U - PROFILE

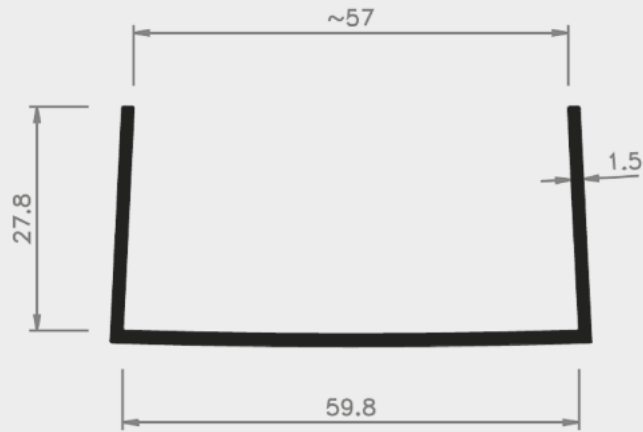

Nr. 39/36 H

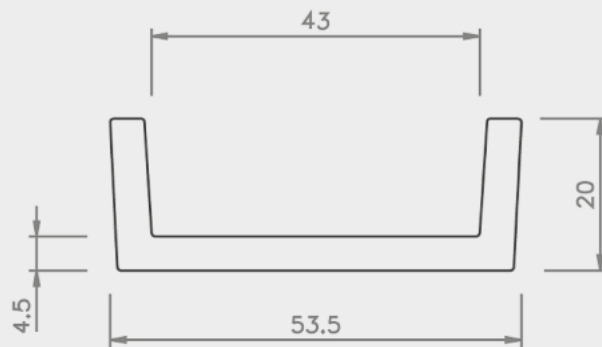

Nr. 51/36 PP



Nr. 39/37 H

■ = Hart PVC ■ = Weich PVC | HH = Halbhart PVC □ = Andere Kunststoffe