

29 | WINKELPROFILE

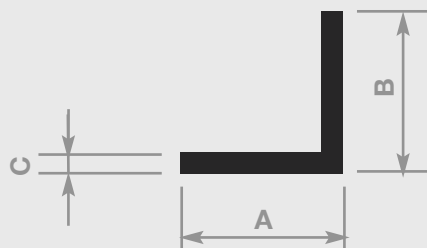

| Profil Nr. | A | B | C | Profil Nr. | A | B | C |
|------------|----|----|-----|------------|-----|----|-----|
| 36/63 | 20 | 10 | 2 | 60/63 | 70 | 25 | 3 |
| 09/63 | 20 | 15 | 2 | 45/63 | 70 | 50 | 2 |
| 11/63 | 27 | 11 | 2 | 46/63 | 70 | 60 | 2 |
| 37/63 | 30 | 10 | 2 | 53/63 | 75 | 20 | 3 |
| 37/63a | 30 | 10 | 3 | 50/63 | 80 | 20 | 2 |
| 38/63 | 30 | 20 | 2 | 50/63a | 80 | 20 | 3 |
| 25/63 | 30 | 20 | 2,5 | 52/63a | 80 | 50 | 2 |
| 08/63 | 37 | 12 | 2 | 52/63 | 80 | 50 | 3 |
| 39/63 | 40 | 20 | 2 | 47/63 | 80 | 60 | 2,5 |
| 39/63a | 40 | 20 | 3 | 55/63 | 80 | 60 | 3 |
| 40/63 | 40 | 30 | 2 | 49/63a | 90 | 20 | 2 |
| 26/63a | 50 | 12 | 3 | 49/63 | 90 | 20 | 3 |
| 41/63 | 50 | 30 | 2 | 61/63 | 90 | 25 | 3 |
| 56/63 | 50 | 30 | 3 | 07/64 | 100 | 20 | 2 |
| 42/63 | 50 | 40 | 2 | 51/63 | 100 | 60 | 2,5 |
| 04/63 | 55 | 12 | 2 | 54/63 | 100 | 60 | 3 |
| 05/63 | 55 | 45 | 2 | 48/63 | 110 | 80 | 3 |
| 65/63 | 59 | 42 | 5 | 57/63 | 150 | 70 | 3 |
| 02/63 | 60 | 30 | 2 | | | | |
| 43/63 | 60 | 40 | 2 | | | | |
| 43/63a | 60 | 40 | 3 | | | | |
| 44/63 | 60 | 50 | 2 | | | | |
| 44/63a | 60 | 50 | 3 | | | | |

= Hart PVC
 = Weich PVC | HH = Halbhart PVC
 = Andere Kunststoffe

29 | WINKELPROFILE

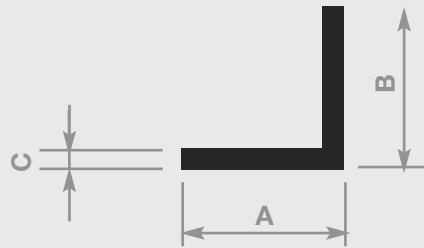

| Profil Nr. | A | B | C |
|------------|----|----|---|
| 62/63 | 10 | 10 | 2 |
| 30/63 | 15 | 15 | 2 |
| 31/63 | 20 | 20 | 2 |
| 31/63a | 20 | 20 | 3 |
| 32/63 | 30 | 30 | 2 |
| 32/63a | 30 | 30 | 3 |
| 33/63 | 40 | 40 | 2 |
| 34/63 | 50 | 50 | 2 |
| 34/63a | 50 | 50 | 3 |
| 35/63 | 60 | 60 | 2 |

= Hart PVC
 = Weich PVC | HH = Halbhart PVC
 = Andere Kunststoffe

29 | WINKELPROFILE

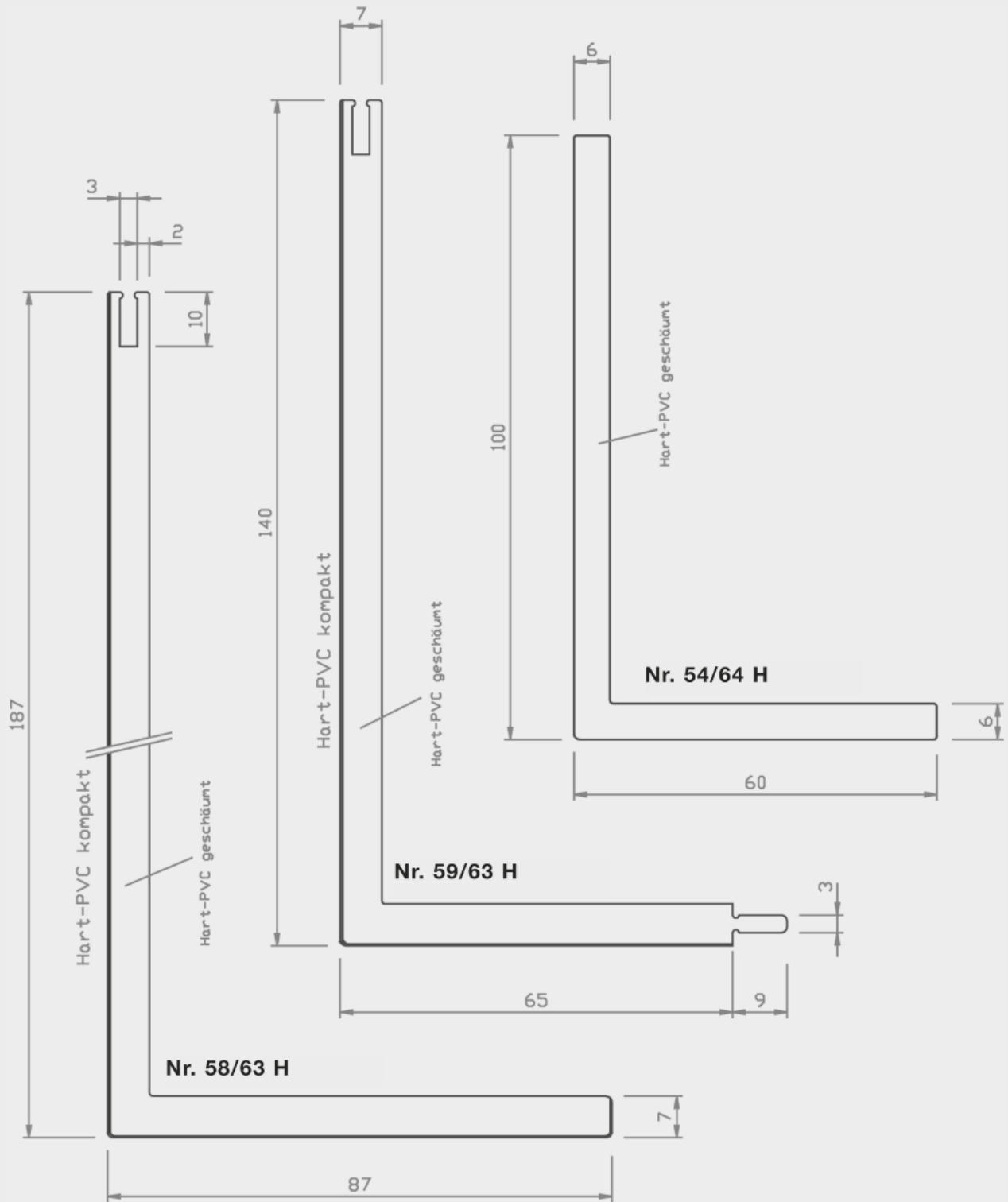

= Hart PVC
 = Weich PVC | HH = Halbhart PVC
 = Andere Kunststoffe

29 | WINKELPROFILE

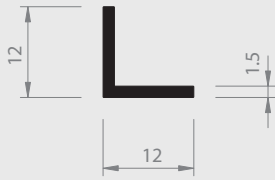

Nr.30/63a H

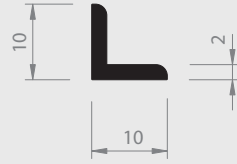

Nr.13/62 H

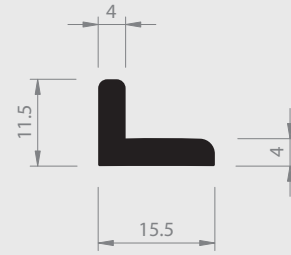

Nr.12/62c H



Nr.13/17 H

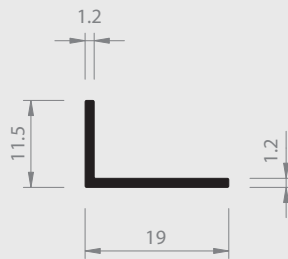

Nr.6/63 H



Nr.3/63 W

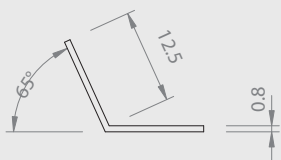

Nr. 20/38 PE

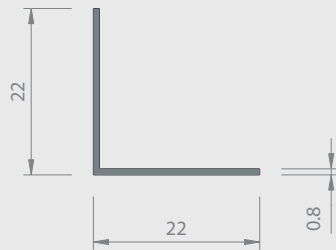

Nr.41/15 W

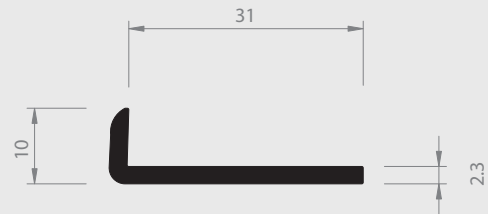

Nr.64/63 H

= Hart PVC
 = Weich PVC | HH = Halbhart PVC
 = Andere Kunststoffe

29 | WINKELPROFILE



Nr. 67/63 PP

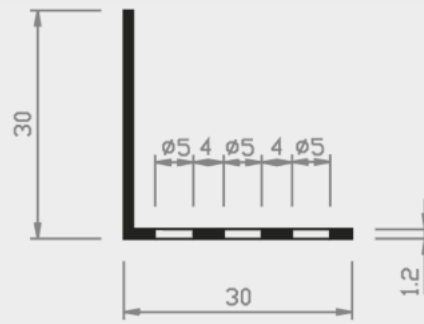

Nr. 7/63 H

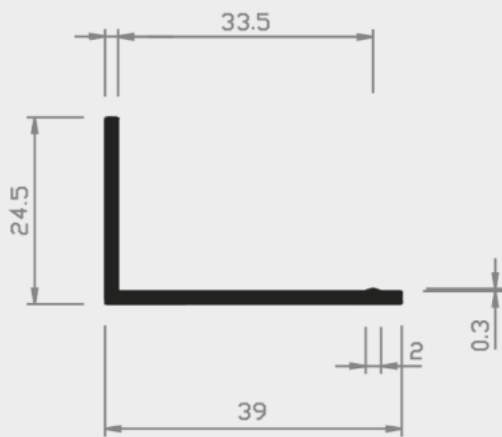

Nr. 19/63 H

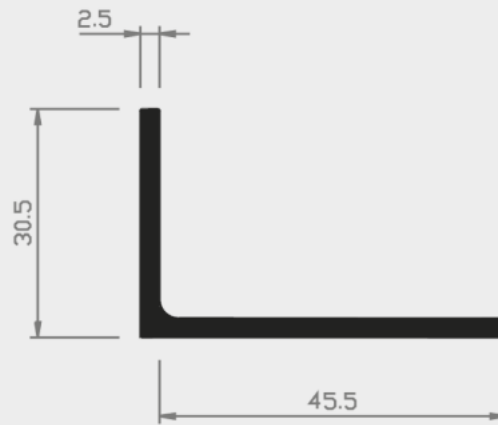

Nr. 16/63 H

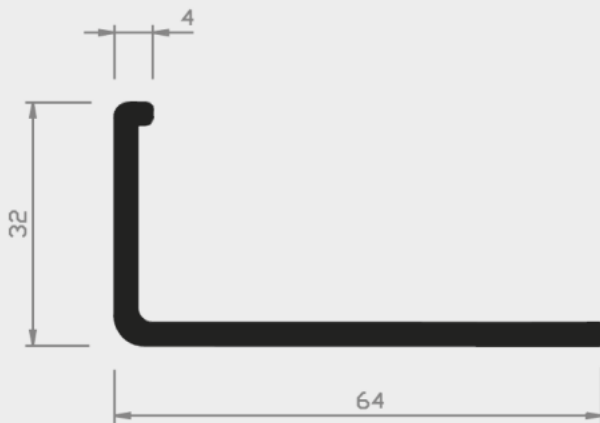

Nr. 27/63 H

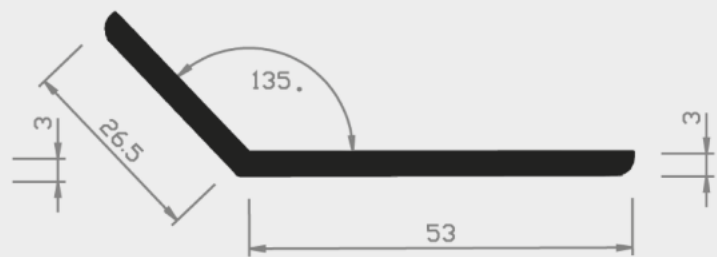

Nr. 11/18 H

= Hart PVC
 = Weich PVC | HH = Halbhart PVC
 = Andere Kunststoffe

29 | WINKELPROFILE

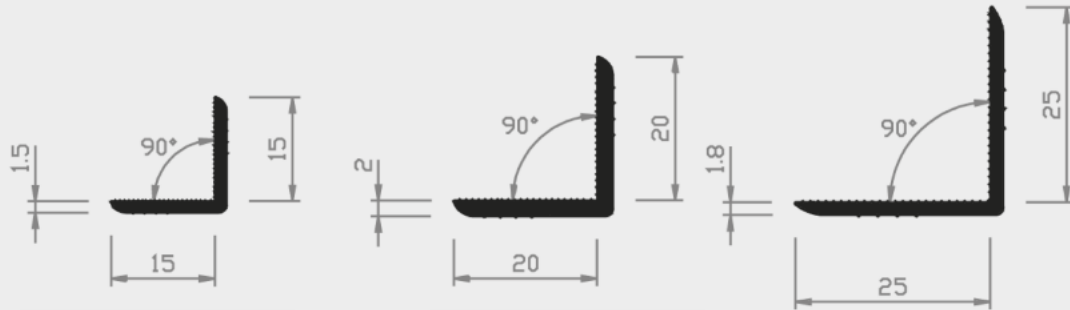

Nr. 15/63 H
15 X 15

Nr. 15/63 H
20 x 20

Nr. 14/63 H
25 x 25

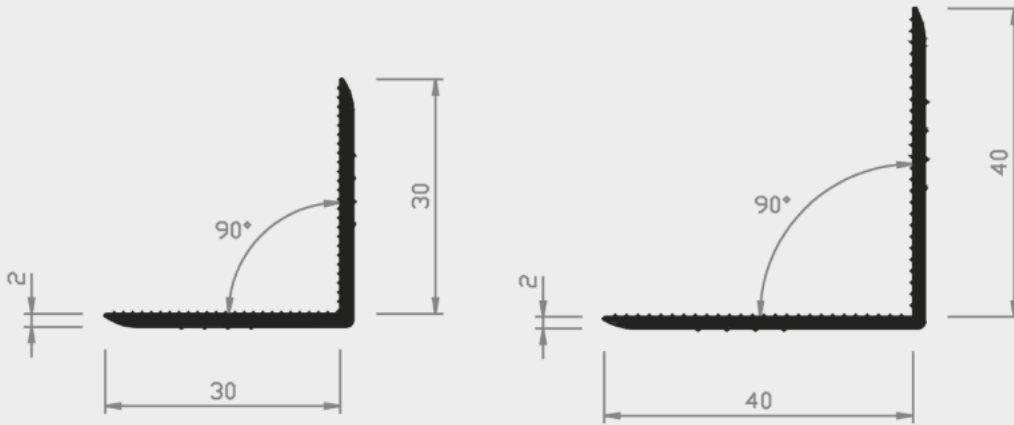

Nr. 14/63 H
30 x 30

Nr. 13/63 H
40 x 40

= Hart PVC
 = Weich PVC | HH = Halbhart PVC
 = Andere Kunststoffe

29 | WINKELPROFILE



Nr.10/61 H



Nr.10/62 H



Nr.10/63 H



Nr.11/62 H

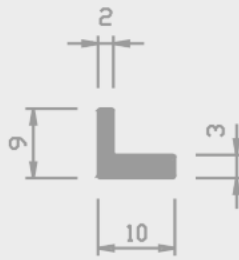

Nr.28/63 W

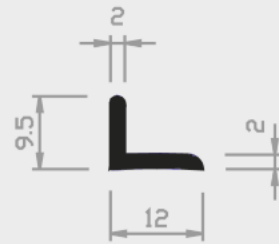

Nr.24/63 H



Nr.12/62 H



Nr.12/62a H

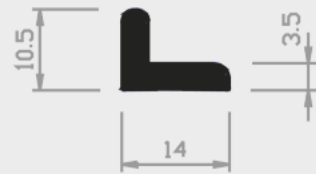

Nr.12/62b H

= Hart PVC
 = Weich PVC | HH = Halbhart PVC
 = Andere Kunststoffe

29 | WINKELPROFILE

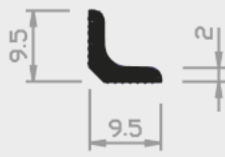

Nr.10/68 H

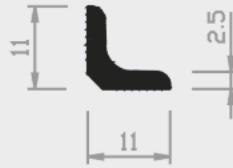

Nr.10/68a H



Nr.11/63b H 25mm

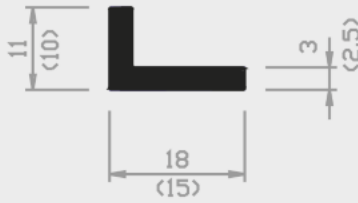

Nr.12/63 H 18 mm
Nr.12/63aH (15)mm

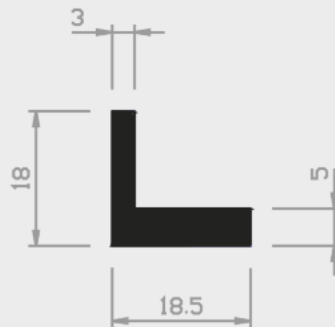

Nr.22/63 H

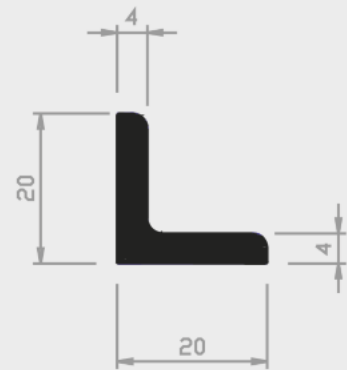

Nr.11/64 H

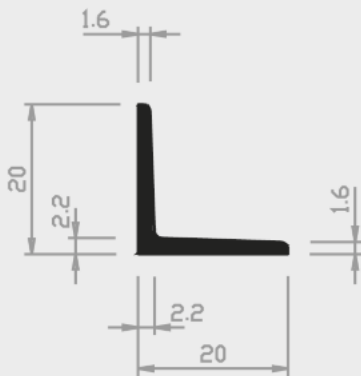

Nr.23/63 H



Nr.11/63a H 22mm



Nr.12/68 H

= Hart PVC
 = Weich PVC | HH = Halbhart PVC
 = Andere Kunststoffe

29 | WINKELPROFILE

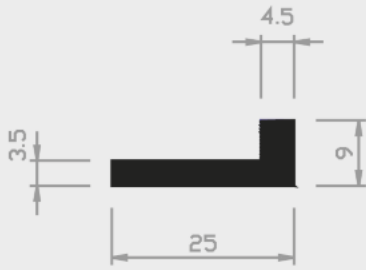

Nr.21/63 H



Nr.13/64 H

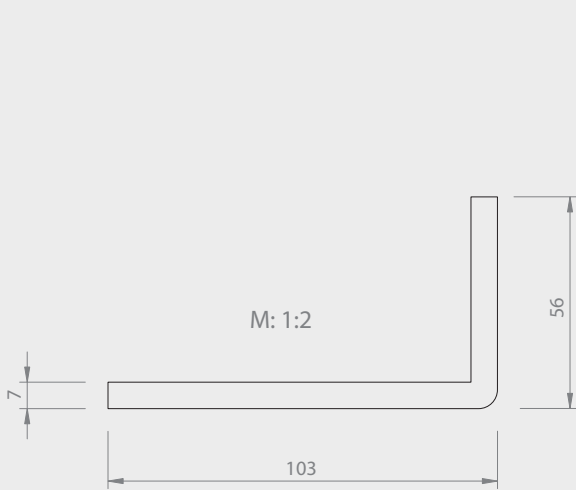

Nr. 64/65 PP

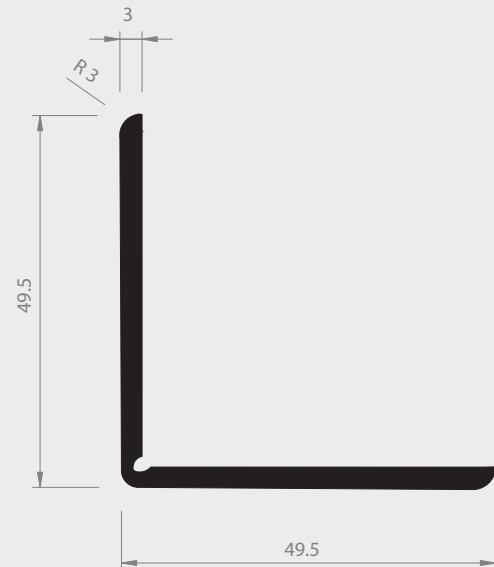

Nr. 06/64 H

= Hart PVC
 = Weich PVC | HH = Halbhart PVC
 = Andere Kunststoffe