

29 | WINKELPROFILE

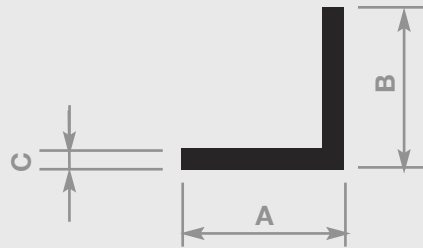

Profil Nr.	A	B	C	Profil Nr.	A	B	C
36/63	20	10	2	60/63	70	25	3
09/63	20	15	2	45/63	70	50	2
11/63	27	11	2	46/63	70	60	2
37/63	30	10	2	53/63	75	20	3
37/63a	30	10	3	50/63	80	20	2
38/63	30	20	2	50/63a	80	20	3
25/63	30	20	2,5	52/63a	80	50	2
08/63	37	12	2	52/63	80	50	3
39/63	40	20	2	47/63	80	60	2,5
39/63a	40	20	3	55/63	80	60	3
40/63	40	30	2	49/63a	90	20	2
26/63a	50	12	3	49/63	90	20	3
41/63	50	30	2	61/63	90	25	3
56/63	50	30	3	07/64	100	20	2
42/63	50	40	2	51/63	100	60	2,5
04/63	55	12	2	54/63	100	60	3
05/63	55	45	2	48/63	110	80	3
65/63	59	42	5	57/63	150	70	3
02/63	60	30	2				
43/63	60	40	2				
43/63a	60	40	3				
44/63	60	50	2				
44/63a	60	50	3				

= Hart PVC
 = Weich PVC | HH = Halbhart PVC
 = Andere Kunststoffe

29 | WINKELPROFILE

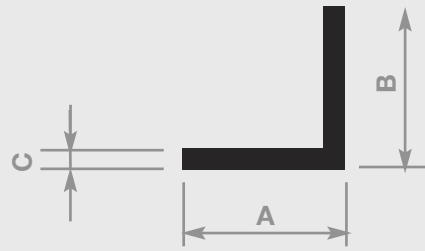

Profil Nr.	A	B	C
62/63	10	10	2
30/63	15	15	2
31/63	20	20	2
31/63a	20	20	3
32/63	30	30	2
32/63a	30	30	3
33/63	40	40	2
34/63	50	50	2
34/63a	50	50	3
35/63	60	60	2

= Hart PVC
 = Weich PVC | HH = Halbhart PVC
 = Andere Kunststoffe

29 | WINKELPROFILE

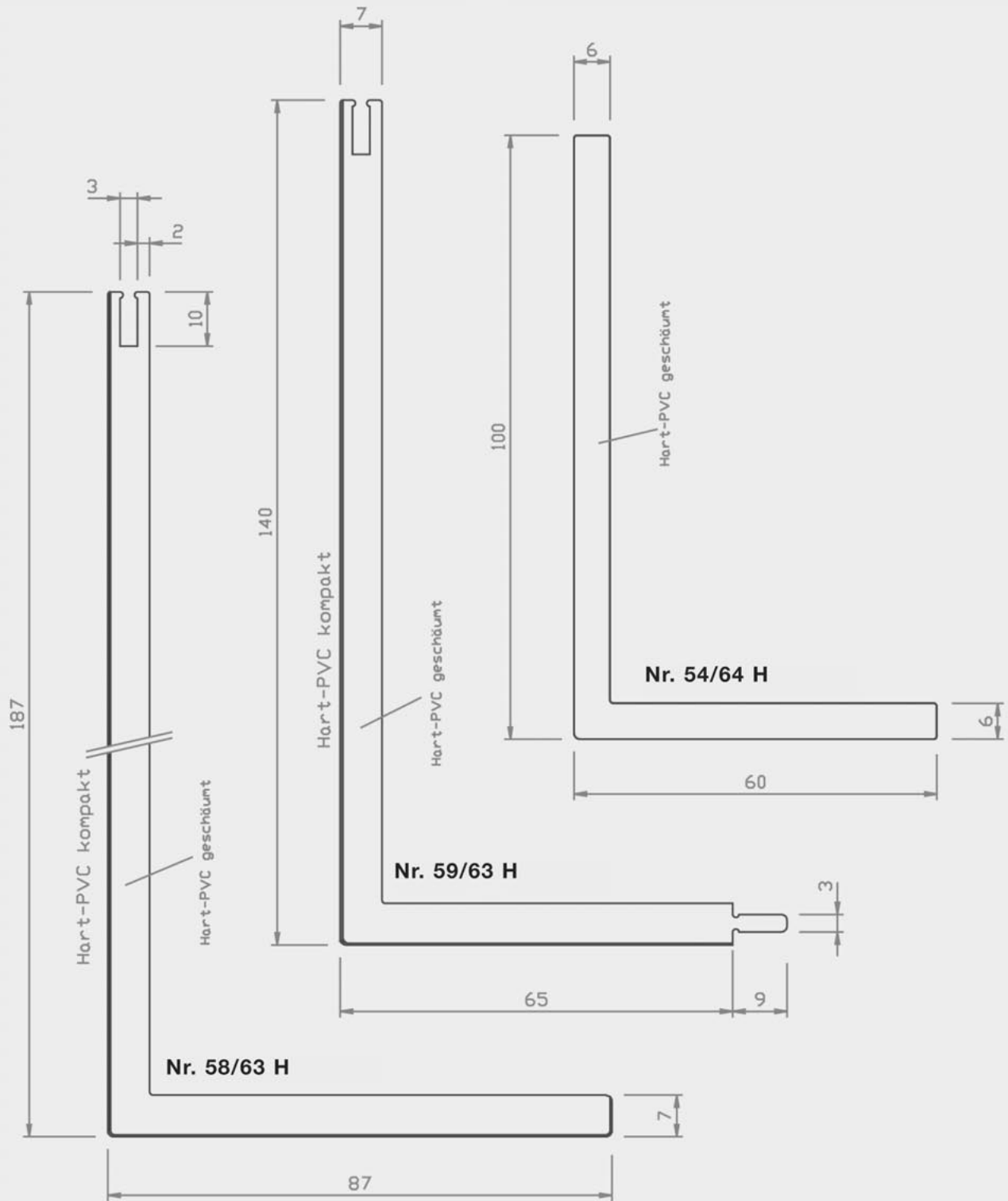

= Hart PVC
 = Weich PVC | HH = Halbhart PVC
 = Andere Kunststoffe

29 | WINKELPROFILE

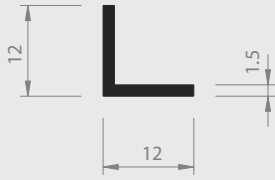

Nr.30/63a H

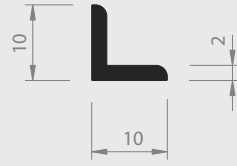

Nr.13/62 H

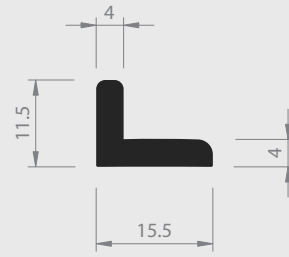

Nr.12/62c H

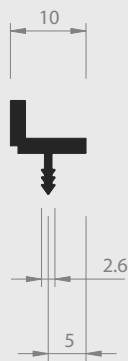

Nr.13/17 H

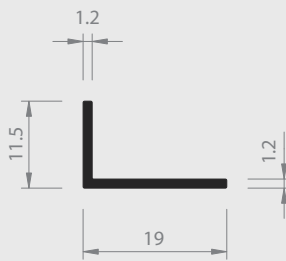

Nr.6/63 H

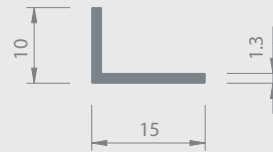

Nr.3/63 W

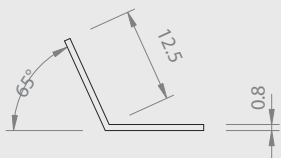

Nr. 20/38 PE



Nr.41/15 W

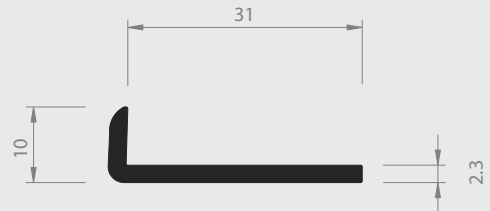

Nr.64/63 H

■ = Hart PVC

■ = Weich PVC | HH = Halbhart PVC

□ = Andere Kunststoffe

29 | WINKELPROFILE

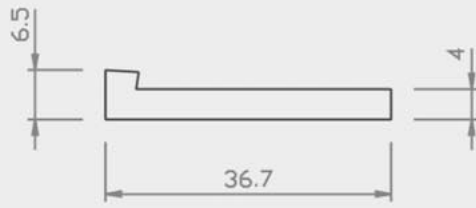

Nr. 67/63 PP

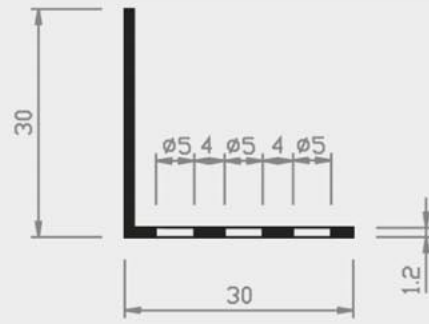

Nr. 7/63 H

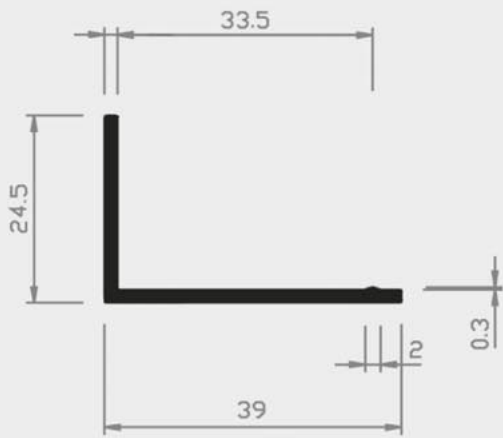

Nr. 19/63 H

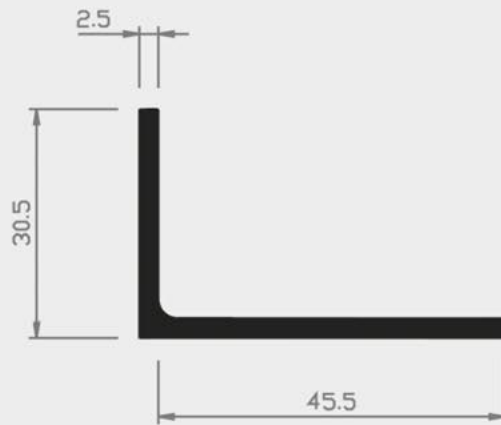

Nr. 16/63 H

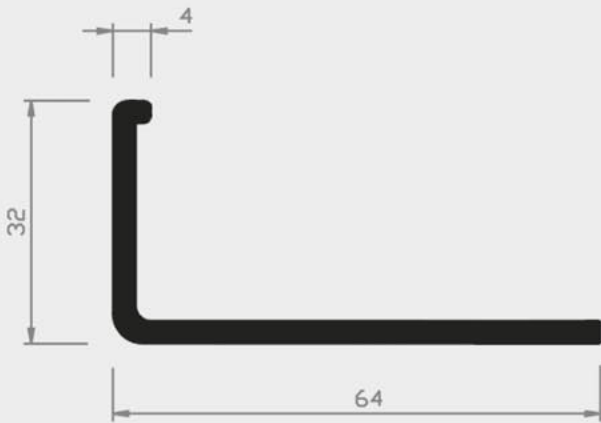

Nr. 27/63 H

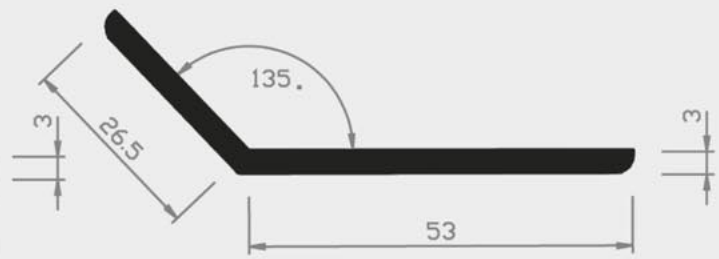

Nr. 11/18 H

= Hart PVC
 = Weich PVC | HH = Halbhart PVC
 = Andere Kunststoffe

29 | WINKELPROFILE

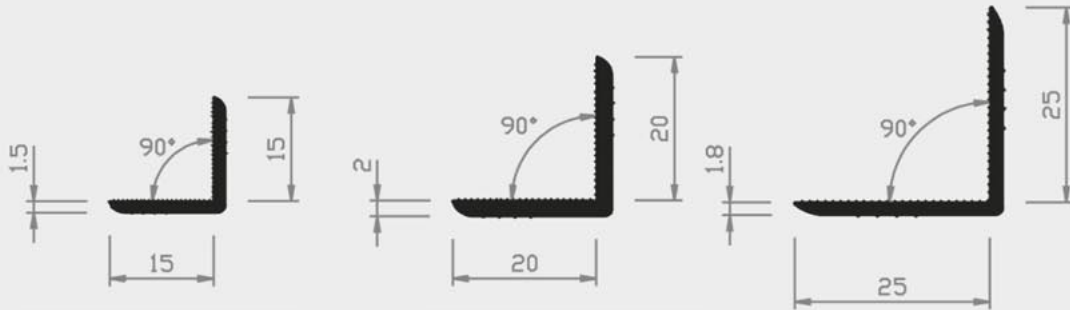

Nr. 15/63 H
15 X 15

Nr. 15/63 H
20 x 20

Nr. 14/63 H
25 x 25

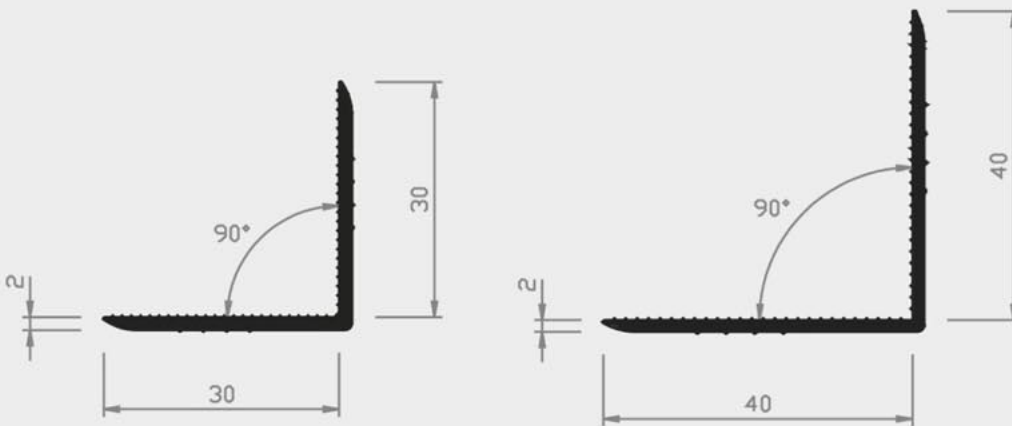

Nr. 14/63 H
30 x 30

Nr. 13/63 H
40 x 40

= Hart PVC
 = Weich PVC | HH = Halbhart PVC
 = Andere Kunststoffe

29 | WINKELPROFILE



Nr.10/61 H



Nr.10/62 H



Nr.10/63 H

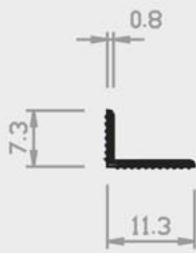

Nr.11/62 H

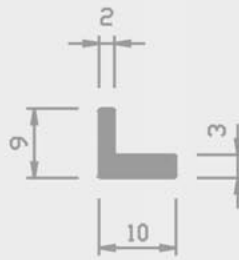

Nr.28/63 W

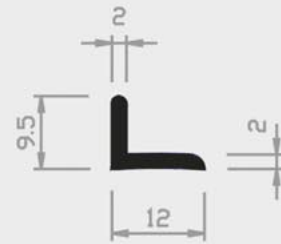

Nr.24/63 H



Nr.12/62 H



Nr.12/62a H

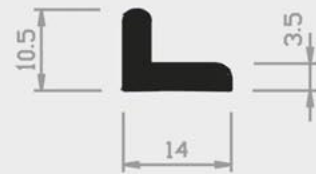

Nr.12/62b H

= Hart PVC
 = Weich PVC | HH = Halbhart PVC
 = Andere Kunststoffe

29 | WINKELPROFILE

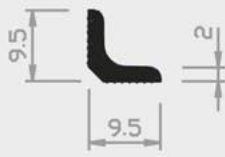

Nr.10/68 H

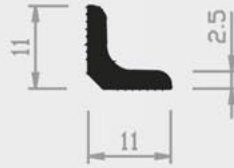

Nr.10/68a H



Nr.11/63b H 25mm

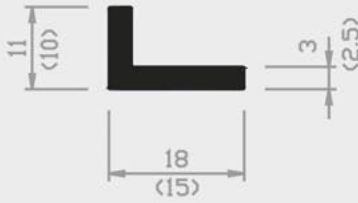

Nr.12/63 H 18 mm
Nr.12/63aH (15)mm

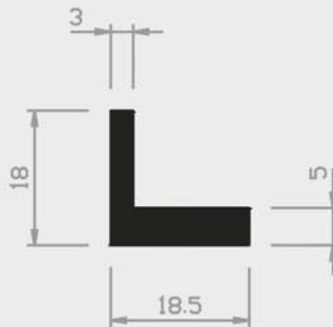

Nr.22/63 H

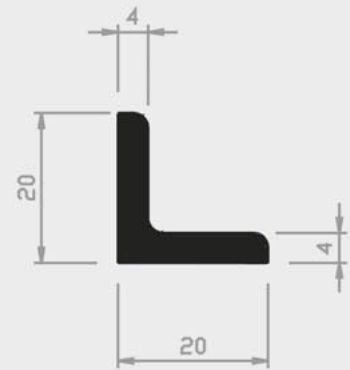

Nr.11/64 H

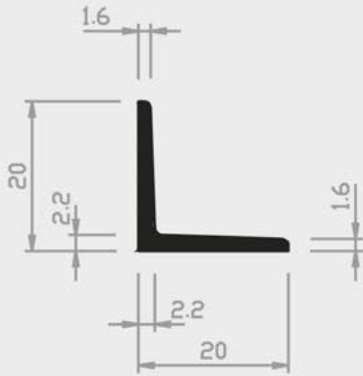

Nr.23/63 H

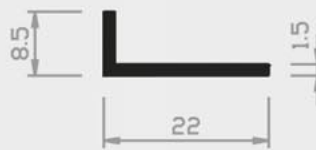

Nr.11/63a H 22mm

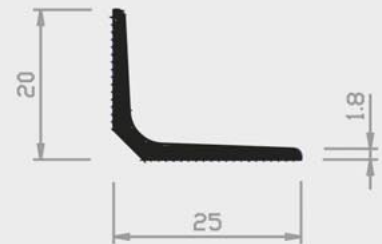

Nr.12/68 H

= Hart PVC
 = Weich PVC | HH = Halbhart PVC
 = Andere Kunststoffe

29 | WINKELPROFILE

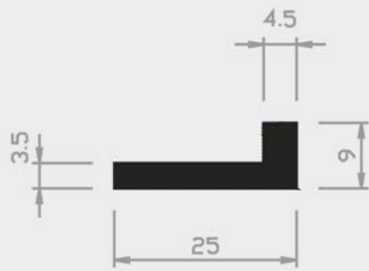

Nr.21/63 H



Nr.13/64 H

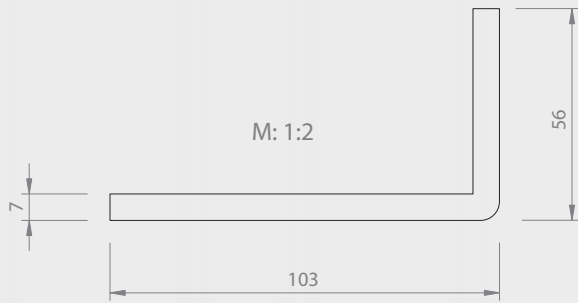

Nr. 64/65 PP

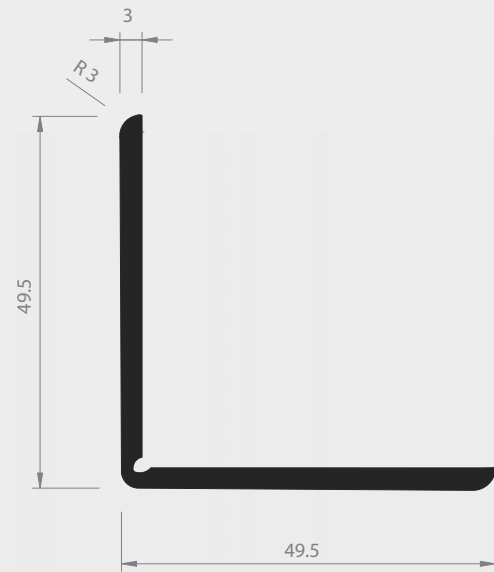

Nr. 06/64 H

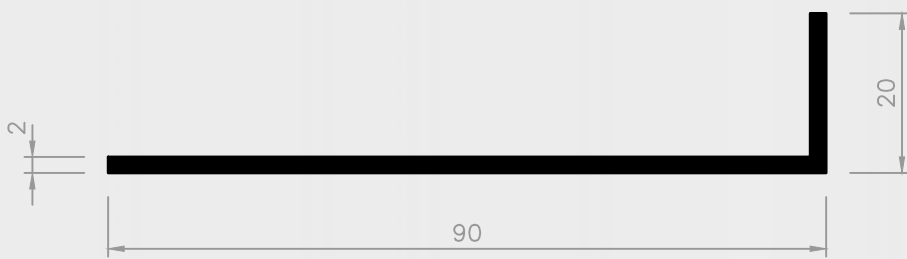

Nr. 49/63B H

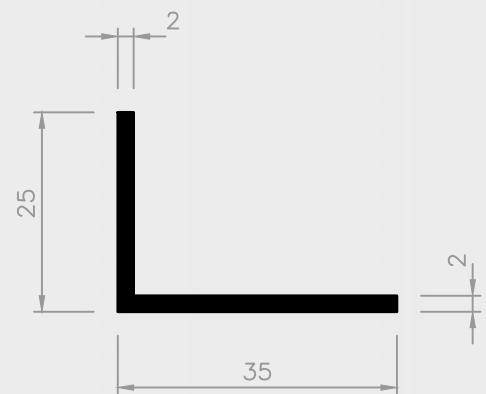

Nr. 63/63 H

= Hart PVC
 = Weich PVC | HH = Halbhart PVC
 = Andere Kunststoffe