

# 30 | ZIERLEISTEN

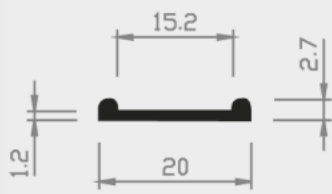

Nr. 33/33 H

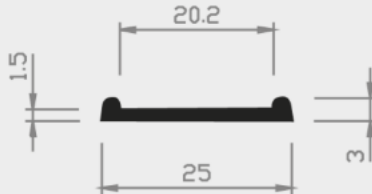

Nr. 32/33 H

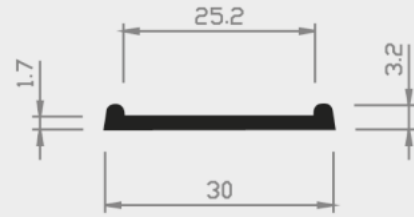

Nr. 31/33 H

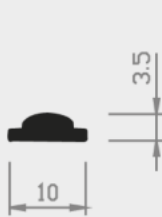

Nr. 25/33 H

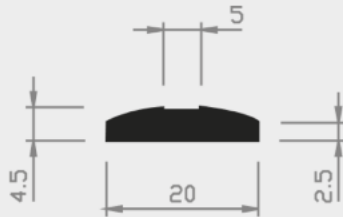

Nr. 26/33 H

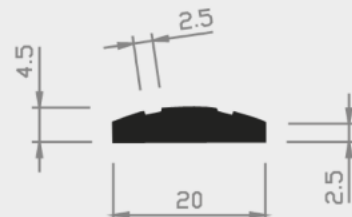

Nr. 27/33 H



Nr. 28/33 H

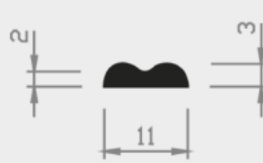

Nr. 34/33 H

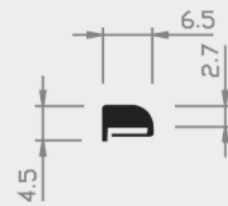

Nr. 34/34 H  
selbstklebend



Nr. 10/87 H



Nr. 6/8 H



Nr. 17/11a H

■ = Hart PVC

■ = Weich PVC | HH = Halbhart PVC

□ = Andere Kunststoffe

# 30 | ZIERLEISTEN

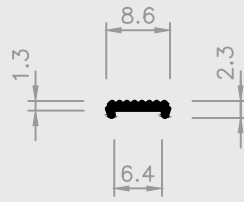

Nr. 24/65 H

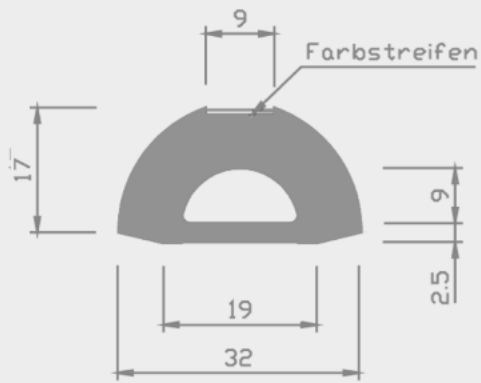

Nr. 52/20 W  
2-farbig

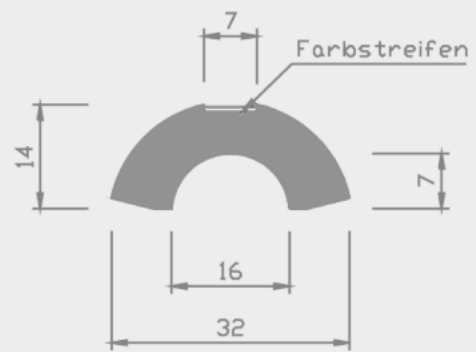

Nr. 50/20 W  
2-farbig

■ = Hart PVC    ■ = Weich PVC | HH = Halbhart PVC    □ = Andere Kunststoffe